



LAMP CATALOG



WESTINGHOUSE LIGHTING

CONTENTS

INTRODUCTION	2-4
Our Story.....	2-3
Lamp Reference Guide.....	4
LED LAMPS	5-19
HALOGEN LAMPS	20-23
INCANDESCENT LAMPS	24-30
INDEX	31-32



All Westinghouse Lighting light fixtures, ceiling fans and accessories are Underwriter Laboratories, ETL Listed or RU Certified for safety. Lamps are not included with product unless otherwise noted.

Westinghouse Lighting recommends using Westinghouse lamps in all of our ceiling fans and light fixtures. We reserve the right to make changes and/or improvements (both visually and technically) to the products in this catalog without notice. As a result, some products and/or product information may change.

Visit our website for the latest specifications.

A LEADER IN LIGHTING SINCE 1946

It all started in 1946 with two brothers and a small corner store in South Philadelphia. From this humble beginning, Angelo Brothers evolved into Westinghouse Lighting and the industry leader that we are today.

For over 75 years, our customers have always been our top priority. While our company has grown in both size and scope, we have remained committed to our core values of customer service, quality products, and sustainability.



Our Founders: Romolo & Stanley Angelo

We are proud to be one of the few privately held, multi-generational family businesses in the lighting manufacturing industry. Our team combines generations of experience with exceptional industry knowledge. As the only global lighting company to carry a complete line of lighting fixtures, ceiling fans, lamps, and lighting accessories, we are well-positioned to suit the ever-evolving needs of our residential and commercial customers alike.



Angelo Brothers rebrands as Westinghouse Lighting and begins marketing lighting fixtures, ceiling fans, lamps (light bulbs), and lighting accessories globally.

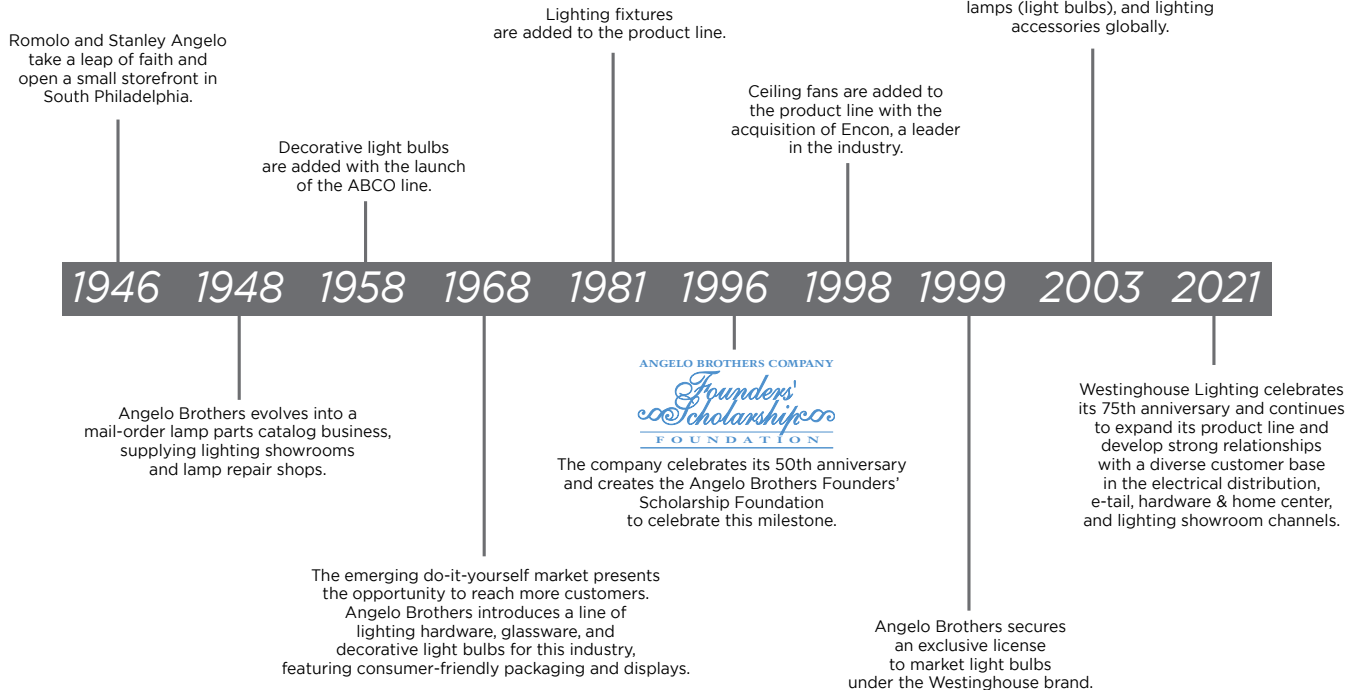

WHAT SETS US APART

DEDICATION TO CUSTOMER SERVICE

Our team strives to deliver the best customer experience every time. Our ability to consistently provide quality products, timely shipments, and friendly service has earned us a reputation of trust with new and long-standing customers alike.



QUALITY PRODUCTS & COMPETITIVE PRICING

We believe well-made products should also be accessible. Our strong supplier relationships allow us to provide our customers with competitive pricing on our vast assortment of high-quality lighting solutions. We offer a wide selection of indoor & outdoor lighting fixtures, ceiling fans, lamps, and lighting accessories at various price points, to ensure we have the perfect product for any need.



OUR TEAM

Our knowledgeable, experienced, and tight-knit team has been the cornerstone in our continued success and growth throughout the years. Our team is always available to offer support and guidance for all your lighting needs.

INDUSTRY KNOWLEDGE

Our dedicated team is passionate about lighting and keeping up with the latest trends, styles, and products for both residential and commercial markets.



LAMP REFERENCE GUIDE

Our lamp charts are full of information. Below is a breakdown of what it all means.

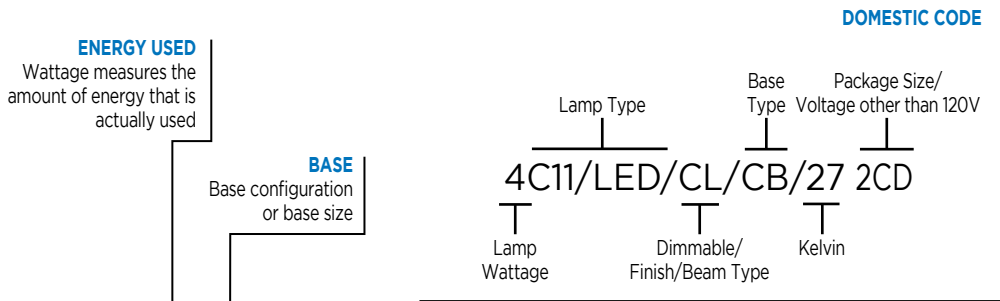

LED LAMPS

DECORATIVE LAMPS

Item No.	Energy Used (Watts)	Lamp Base	Footnotes	Domestic Code	Package Type	Equiv. Incand. Wattage	Color Designation	Finish	Color Temperature (Kelvin)	CRI	Brightness (Lumens)	Avg. Rated Hours	Life in Years*	Est. Yearly Energy Cost**	MOL
TORPEDO															
43045	2.8	Cand.	2,4,7	2.8B11/LED/DIM/CL/CB/30	Hanging Box	25	Warm White	Clear	3000	80	160	25000	22.8	\$0.34	3.78*
50691	3.5	Cand.	2,4,7	3.5B11/LED/DIM/CL/CB/27	Box	40	Warm White	Clear	2700	90	300	25000	22.8	\$0.42	3.78*
50701	3.5	Med.	2,4,7	3.5B11/LED/DIM/CL/27	Box	40	Warm White	Clear	2700	90	300	25000	22.8	\$0.42	3.78*
53141	4.5	Cand.	2,4,7	4.5B11/LED/DIM/CL/CB/27	Hanging Box	40	Warm White	Clear	2700	80	300	25000	22.8	\$0.54	3.78*
53130	6.5	Cand.	2,4,7	6.5B13/LED/DIM/CL/CB/27	Hanging Box	60	Warm White	Clear	2700	80	500	25000	22.8	\$0.78	4.49*
FLAME TIP															
45124	4	Cand.	2,4,7	4C11/LED/CL/CB/27 2CD	Card (2)	40	Warm White	Clear	2700	80	300	15000	13.6	\$0.48	4.00*
45129	7	Cand.	2,4,7	7C13/LED/CL/CB/27 2CD	Card (2)	60	Warm White	Clear	2700	80	500	15000	13.6	\$0.84	4.49*

*Based on 3 hrs./day **Based on 3 hrs./day 11¢/kWh

Can be used to comply with the 2022 Title 24, part 6, high efficacy light source requirements.

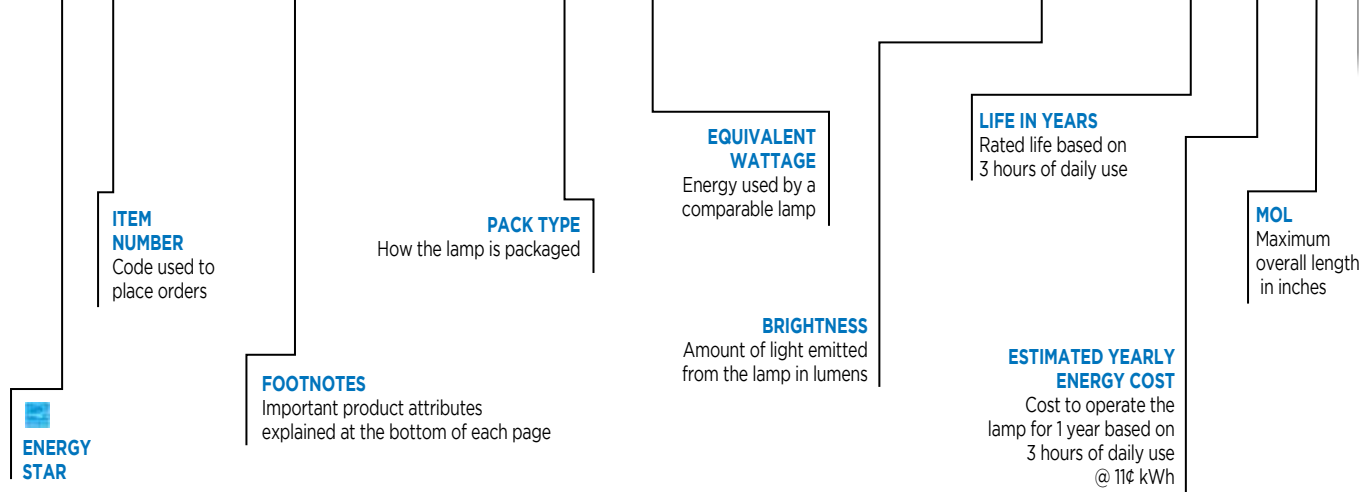

ENERGY-EFFICIENT LED LIGHTING

Our LED lamp assortment offers longer life and enhanced light output, as well as significant energy and cost savings when compared to other light sources. Westinghouse LED lamps are available in a variety of shapes and sizes for residential and commercial applications.



DECORATIVE FILAMENT LAMPS LAMPS SHOWN UNLIT



B11 CLEAR



CA11 CLEAR



F15 CLEAR

Item No.	Energy Used (Watts)	Lamp Base	Footnotes	Domestic Code	Package Type	Equiv. Incand. Wattage	Color Designation	Finish	Color Temperature (Kelvin)	Brightness (Lumens)	Avg. Rated Hours	Life in Years*	Est. Yearly Energy Cost**	MOL
B11 DECORATIVE														
50592	2	Cand.	1,2,4,7	2B11/FilamentLED/DIM/CL/CB/27	Box	25	Warm White	Clear	2700	80	200	15000	13.6	\$0.24 3.82"
45171	3.3	Cand.	1,2,4,7	3.3B11/FilamentLED/DIM/CL/CB/27	Box	40	Warm White	Clear	2700	80	300	15000	13.6	\$0.40 3.82"
52630	4	Cand.	1,2,4,7	4B11/FilamentLED/DIM/CL/CB/30	Box	40	Warm White	Clear	3000	80	300	15000	13.6	\$0.48 3.74"
50621	4.5	Cand.	2,4,7	4.5B11/FilamentLED/DIM/CL/CB/27 2CD	Card (2)	60	Warm White	Clear	2700	80	500	15000	13.6	\$0.54 3.82"
52710	4.5	Cand.	1,2,5,7	4.5B11/FilamentLED/DIM/CL/CB/27	Box	60	Warm White	Clear	2700	80	500	15000	13.6	\$0.54 3.82"
52651	4.5	Cand.	1,2,5,7	4.5B11/FilamentLED/DIM/CL/CB/30	Box	60	Warm White	Clear	3000	80	500	15000	13.6	\$0.54 3.74"
43169	4.5	Med.	2,4,7	4.5B11/FilamentLED/DIM/CL/27	Box	60	Warm White	Clear	2700	80	500	15000	13.6	\$0.54 3.58"
CA11 DECORATIVE														
45172	3.3	Cand.	1,2,4,7	3.3CA11/FilamentLED/DIM/CL/CB/27	Box	40	Warm White	Clear	2700	80	300	15000	13.6	\$0.40 4.29"
52640	4	Cand.	1,2,4,7	4CA11/FilamentLED/DIM/CL/CB/30	Box	40	Warm White	Clear	3000	80	300	15000	13.6	\$0.48 4.17"
52720	4.5	Cand.	1,2,5,7	4.5CA11/FilamentLED/DIM/CL/CB/27	Box	60	Warm White	Clear	2700	80	500	15000	13.6	\$0.54 4.29"
52660	4.5	Cand.	1,2,4,7	4.5CA11/FilamentLED/DIM/CL/CB/30	Box	60	Warm White	Clear	3000	80	500	15000	13.6	\$0.54 4.17"
43171	4.5	Med.	2,4,7	4.5CA11/FilamentLED/DIM/CL/27	Box	60	Warm White	Clear	2700	80	500	15000	13.6	\$0.54 4.13"
F15														
33193	2.5	Med.	2,4,7	2.5F15/FilamentLED/DIM/CL/27 1CD	Card	25	Warm White	Clear	2700	80	250	15000	13.6	\$0.30 4.33"

*Based on 3 hrs./day

**Based on 3 hrs./day 11¢/kWh

See individual product specification sheets for dimmer and ballast compatibility on www.westinghouselighting.com.

Footnotes

- 1 New Item
- 2 Dimmable
- 3 Low Voltage (12V)
- 4 Approved for Damp Location
- 5 Approved for Wet Location
- 6 Indoor Application Only
- 7 Approved for Use in Totally Enclosed Fixtures

FILAMENT
T LAMPS
LAMPS SHOWN UNLIT



Item No.	Energy Used (Watts)	Lamp Base	Footnotes	Domestic Code	Package Type	Equiv. Incand. Wattage	Color Designation	Finish	Color Temperature (Kelvin)	CRI	Brightness (Lumens)	Avg. Rated Hours	Life in Years*	Est. Yearly Energy Cost**	MOL
T6															
51581	2.5	Cand.	1,2,5,7	2.5T6/FilamentLED/DIM/CL/CB/27	Box	25	Warm White	Clear	2700	80	200	15000	13.6	\$0.30	3.00"
51681	4.5	Cand.	1,2,5,7	4.5T6/FilamentLED/DIM/CL/CB/27	Box	40	Warm White	Clear	2700	80	450	15000	13.6	\$0.54	3.00"
T6.5															
51941	3.5	Inter.	1,2,5,7	3.5T6.5/FilamentLED/DIM/CL/IN/27	Box	40	Warm White	Clear	2700	80	350	15000	13.6	\$0.42	4.65"
T9															
45184	4.5	Med.	2,4,7	4.5T9/FilamentLED/DIM/CL/27 1CD	Box	60	Warm White	Clear	2700	80	450	15000	13.6	\$0.54	7.10"
45188	6.5	Med.	1,2,4,7	6.5T9/FilamentLED/DIM/CL/27 1CD	Box	75	Warm White	Clear	2700	80	800	15000	13.6	\$0.78	11.81"
T10															
45185	3.5	Med.	2,4,7	3.5T10/FilamentLED/DIM/CL/27 1CD	Card	60	Warm White	Clear	2700	80	350	15000	13.6	\$0.42	4.92"

*Based on 3 hrs./day

**Based on 3 hrs./day 11¢/kWh

See individual product specification sheets for dimmer and ballast compatibility on www.westinghouselighting.com.**Footnotes**1 New Item
2 Dimmable3 Low Voltage (12V)
4 Approved for Damp Location5 Approved for Wet Location
6 Indoor Application Only

7 Approved for Use in Totally Enclosed Fixtures

FILAMENT LAMPS

LAMPS SHOWN UNLIT



Item No.	Energy Used (Watts)	Lamp Base	Footnotes	Domestic Code	Equiv. Package Type	Incand. Wattage	Color Designation	Finish	Color Temperature (Kelvin)	Brightness CRI	(Lumens)	Avg. Rated Hours	Life in Years*	Est. Yearly Energy Cost**	MOL
A15															
43166	4.5	Med.	2,4,7	4.5A15/FilamentLED/DIM/CL/27	Box	40	Warm White	Clear	2700	80	470	15000	13.6	\$0.54	3.30"
52800	4.5	Med.	1,2,4,7	4.5A15/FilamentLED/DIM/CL/30	Box	40	Warm White	Clear	3000	80	470	15000	13.6	\$0.54	3.23"
52770	6	Med.	1,2,4,7	6A15/FilamentLED/DIM/CL/30	Box	60	Warm White	Clear	3000	80	600	15000	13.6	\$0.72	3.23"
52780	8	Med.	1,2,4,7	8A15/FilamentLED/DIM/CL/30	Box	75	Warm White	Clear	3000	80	800	15000	13.6	\$0.96	3.23"
52790	9	Med.	1,2,4,7	9A15/FilamentLED/DIM/CL/30	Box	100	Warm White	Clear	3000	80	950	15000	13.6	\$1.08	3.23"
A19															
53164	4.5	Med.	2,4,7	4.5A19/FilamentLED/DIM/CL/27	Box	40	Warm White	Clear	2700	80	470	15000	13.6	\$0.54	4.13"
52570	4.5	Med.	2,4,7	4.5A19/FilamentLED/DIM/CL/30	Box	40	Warm White	Clear	3000	80	470	15000	13.6	\$0.54	4.13"
53165	6.5	Med.	2,4,7	6.5A19/FilamentLED/DIM/CL/27	Box	60	Warm White	Clear	2700	80	810	15000	13.6	\$0.78	4.13"
51361	6.5	Med.	2,4,7	6.5A19/FilamentLED/DIM/CL/27 2PK	Box (2)	60	Warm White	Clear	2700	80	810	15000	13.6	\$0.78	4.13"
52580	6.5	Med.	2,4,7	6.5A19/FilamentLED/DIM/CL/30	Box	60	Warm White	Clear	3000	80	810	15000	13.6	\$0.78	4.13"
50163	6.5	Med.	2,4,7	6.5A19/FilamentLED/DIM/SW/27	Box	60	Warm White	Soft White	2700	80	810	15000	13.6	\$0.78	4.13"
51672	8	Med.	2,4,7	8A19/FilamentLED/DIM/CL/27	Box	75	Warm White	Clear	2700	80	1100	15000	13.6	\$0.96	4.13"
52590	8	Med.	2,4,7	8A19/FilamentLED/DIM/CL/30	Box	75	Warm White	Clear	3000	80	1100	15000	13.6	\$0.96	4.13"
52240	9	Med.	2,4,7	9A19/FilamentLED/DIM/CL/27	Box	60	Warm White	Clear	2700	80	800	15000	13.6	\$1.08	4.17"
52550	10	Med.	2,4,7	10A19/FilamentLED/DIM/CL/27	Box	100	Warm White	Clear	2700	80	1600	15000	13.6	\$1.20	4.13"
52600	10	Med.	2,4,7	10A19/FilamentLED/DIM/CL/30	Box	100	Warm White	Clear	3000	80	1600	15000	13.6	\$1.20	4.13"
G16.5 GLOBE															
50242	4.5	Cand.	2,4,7	4.5G16.5/FilamentLED/DIM/CL/CB/27	Box	60	Warm White	Clear	2700	80	500	15000	13.6	\$0.54	3.23"
G25 GLOBE															
51691	4.5	Med.	2,4,7	4.5G25/FilamentLED/DIM/CH/27	Box	40	Warm White	Half Chrome	2700	80	400	15000	13.6	\$0.54	4.72"
43172	5.5	Med.	2,4,7	5.5G25/FilamentLED/DIM/CL/27	Box	40	Warm White	Clear	2700	80	500	15000	13.6	\$0.66	4.52"
50172	5.5	Med.	2,4,7	5.5G25/FilamentLED/DIM/SW/27	Box	40	Warm White	Soft White	2700	80	500	15000	13.6	\$0.66	4.52"
G25 CUT GLASS															
52680	5.5	Med.	1,2,5,7	5.5G25/FilamentLED/DIM/CL/CG/30	Box	40	Warm White	Clear	3000	80	500	15000	13.6	\$0.66	4.80"
G40 GLOBE															
53175	6.5	Med.	2,4,7	6.5G40/FilamentLED/DIM/CL/27	Box	60	Warm White	Clear	2700	80	810	15000	13.6	\$0.78	6.57"
ST15															
45186	4.5	Med.	2,4,7	4.5ST15/FilamentLED/DIM/CL/27	Box	40	Warm White	Clear	2700	80	470	15000	13.6	\$0.54	4.65"
45187	6.5	Med.	2,4,7	6.5ST15/FilamentLED/DIM/CL/27	Box	60	Warm White	Clear	2700	80	800	15000	13.6	\$0.78	4.65"
ST20															
45182	4.5	Med.	2,4,7	4.5ST20/FilamentLED/DIM/CL/27	Box	40	Warm White	Clear	2700	80	500	15000	13.6	\$0.54	5.43"
52610	4.5	Med.	2,4,7	4.5ST20/FilamentLED/DIM/CL/30	Box	40	Warm White	Clear	3000	80	500	15000	13.6	\$0.54	5.43"
45183	6.5	Med.	2,4,7	6.5ST20/FilamentLED/DIM/CL/27	Box	60	Warm White	Clear	2700	80	810	15000	13.6	\$0.78	5.43"
52620	6.5	Med.	2,4,7	6.5ST20/FilamentLED/DIM/CL/30	Box	60	Warm White	Clear	3000	80	810	15000	13.6	\$0.78	5.43"
53178	6.5	Med.	2,4,7	6.5ST20/FilamentLED/DIM/A/22	Box	60	Warm White	Amber	2200	80	630	15000	13.6	\$0.78	5.43"

❖ IP40 Rated See individual product specification sheets for dimmer and ballast compatibility on www.westinghouselighting.com. *Based on 3 hrs./day **Based on 3 hrs./day 11¢/kWh

Footnotes

- 1 New Item
- 2 Dimmable
- 3 Low Voltage (12V)
- 4 Approved for Damp Location
- 5 Approved for Wet Location
- 6 Indoor Application Only
- 7 Approved for Use in Totally Enclosed Fixtures



DECORATIVE LAMPS

Item No.	Energy Used (Watts)	Lamp Base	Footnotes	Domestic Code	Package Type	Equiv. Incand. Wattage	Color Designation	Finish	Color Temperature (Kelvin)	CRI	Brightness (Lumens)	Avg. Rated Hours	Life in Years*	Est. Yearly Energy Cost**	MOL
TORPEDO															
24 50691	3.5	Cand.	2,4,7	3.5B11/LED/DIM/CL/CB/27	Box	40	Warm White	Clear	2700	90	300	25000	22.8	\$0.42	3.78"
FLAME TIP															
45124	4	Cand.	2,4,7	4C11/LED/CL/CB/27 2CD	Card (2)	40	Warm White	Clear	2700	80	300	15000	13.6	\$0.48	4.00"
45129	7	Cand.	2,4,7	7C13/LED/CL/CB/27 2CD	Card (2)	60	Warm White	Clear	2700	80	500	15000	13.6	\$0.84	4.49"

*Based on 3 hrs./day

**Based on 3 hrs./day 11¢/kWh

24 Can be used to comply with the 2022 Title 24, part 6, high efficacy light source requirements.



GLOWESCENT LAMPS

Item No.	Energy Used (Watts)	Lamp Base	Footnotes	Domestic Code	Package Type	Equiv. Incand. Wattage	Color Designation	Finish	Color Temperature (Kelvin)	CRI	Brightness (Lumens)	Avg. Rated Hours	Life in Years*	Est. Yearly Energy Cost**	MOL
C11															
52750	4.5	Cand.	1,2,4,7	4.5C11/GlowescentLED/DIM/CL/CB/30	Box	60	Warm White	Clear	3000	80	480	15000	13.6	\$0.54	4.25"
H19															
52760	6.5	Med.	1,2,4,7	6.5H19/GlowescentLED/DIM/CL/CB/30	Box	60	Warm White	Clear	3000	80	800	15000	13.6	\$0.78	5.79"

*Based on 3 hrs./day

**Based on 3 hrs./day 11¢/kWh

GENERAL PURPOSE LAMPS



OMNIA15

Item No.	Energy Used (Watts)	Lamp Base	Footnotes	Domestic Code	Package Type	Equiv. Incand. Wattage	Color Designation	Finish	Color Temperature (Kelvin)	CRI	Brightness (Lumens)	Avg. Rated Hours	Life in Years*	Est. Yearly Energy Cost**	MOL
OMNIA15															
45134	5	Med.	4,7	5OMNIA15/LED/SW/27 1CD	Card	40	Warm White	Soft White	2700	80	450	15000	13.6	\$0.60	3.54"
45136	5.5	Med.	4,7	5.5OMNIA15/LED/SW/27 1CD	Card	60	Warm White	Soft White	2700	80	600	15000	13.6	\$0.66	3.55"
33191	5.5	Med.	2,4,7	5.5OMNIA15/LED/DIM/SW/27 1CD	Card	40	Warm White	Soft White	2700	80	450	25000	22.8	\$0.66	3.54"

*Based on 3 hrs./day

**Based on 3 hrs./day 11¢/kWh

See individual product specification sheets for dimmer and ballast compatibility on www.westinghouselighting.com.

Footnotes

1 New Item
2 Dimmable3 Low Voltage (12V)
4 Approved for Damp Location5 Approved for Wet Location
6 Indoor Application Only

7 Approved for Use in Totally Enclosed Fixtures

GENERAL PURPOSE LAMPS

OMNI A19
MED. BASEOMNI A19
GU24 BASEA19
MED. BASE

Item No.	Energy Used (Watts)	Lamp Base	Footnotes	Domestic Code	Package Type	Equiv. Incand. Wattage	Color Designation	Finish	Color Temperature (Kelvin)	CRI	Brightness (Lumens)	Avg. Rated Hours	Life in Years*	Est. Yearly Energy Cost**	MOL
OMNI A19															
51321	6	Med.	2,4,7	6OMNIA19/LED/DIM/SW/30	Box	40	Warm White	Soft White	3000	80	480	25000	22.8	\$0.72	4.44"
51319	6	Med.	4,7	6OMNIA19/LED/SW/30	Box	40	Warm White	Soft White	3000	80	480	15000	13.6	\$0.72	4.33"
45156	6	Med.	4,7	6OMNIA19/LED/SW/30 4PK	Box (4)	40	Warm White	Soft White	3000	80	480	15000	13.6	\$0.72	4.33"
45138	6	Med.	4,7	6OMNIA19/LED/SW/50	Box	40	Daylight	Soft White	5000	80	480	15000	13.6	\$0.72	4.33"
43697	9	Med.	4,7	9OMNIA19/LED/SW/27	Box	60	Warm White	Soft White	2700	80	800	25000	22.8	\$1.08	4.33"
51840	9	Med.	2,4,7	9OMNIA19/LED/DIM/SW/27	Box	60	Warm White	Soft White	2700	80	800	25000	22.8	\$1.08	4.44"
51331	9	Med.	2,4,7	9OMNIA19/LED/DIM/SW/30	Box	60	Warm White	Soft White	3000	80	800	25000	22.8	\$1.08	4.44"
51341	9	Med.	2,4,7	9OMNIA19/LED/DIM/SW/50	Box	60	Daylight	Soft White	5000	80	800	25000	22.8	\$1.08	4.44"
50771	9	Med.	2,4,7	9OMNIA19/LED/DIM/SW/40	Box	60	Cool White	Soft White	4000	80	800	25000	22.8	\$1.08	4.44"
53127	9.5	Med.	4,7	9.5OMNIA19/LED/SW/30	Box	60	Warm White	Soft White	3000	80	800	15000	13.6	\$1.14	4.33"
45160	9.5	Med.	4,7	9.5OMNIA19/LED/SW/30 4PK	Box (4)	60	Warm White	Soft White	3000	80	800	15000	13.6	\$1.14	4.33"
45140	9.5	Med.	4,7	9.5OMNIA19/LED/SW/50	Box	60	Daylight	Soft White	5000	80	800	15000	13.6	\$1.14	4.33"
53158	9.8	GU24	2,4,7	9.8OMNIA19/LED/DIM/SW/GU24/27	Box	60	Warm White	Soft White	2700	80	800	25000	22.8	\$1.18	4.33"
53190	11	Med.	4,7	11OMNIA19/LED/SW/30	Box	75	Warm White	Soft White	3000	80	1100	15000	13.6	\$1.32	4.49"
50811	11	Med.	2,4,7	11OMNIA19/LED/DIM/SW/30	Box	75	Warm White	Soft White	3000	80	1100	25000	22.8	\$1.32	4.33"
45141	11	Med.	4,7	11OMNIA19/LED/SW/50	Box	75	Daylight	Soft White	5000	80	1100	15000	13.6	\$1.32	4.49"
55145	11	Med.	2,4,7	11OMNIA19/LED/DIM/SW/50	Box	75	Daylight	Soft White	5000	80	1100	25000	22.8	\$1.32	4.33"
53140	3/9/12	Med.	2,4,7	3/9/12OMNIA19/LED/3WAY/SW/27	Box	30/ 70/ 100	Warm White	Soft White	2700	80	280/ 950/ 1200	25000	22.8	\$1.45	4.65"
50940	15	Med.	2,4,7	15OMNIA19/LED/DIM/SW/27	Box	100	Warm White	Soft White	2700	80	1600	25000	22.8	\$1.81	4.92"
51970	15	Med.	2,4,7	15OMNIA19/LED/DIM/SW/30	Box	100	Warm White	Soft White	3000	80	1600	25000	22.8	\$1.81	4.92"
50750	15	Med.	2,4,7	15OMNIA19/LED/DIM/SW/40	Box	100	Cool White	Soft White	4000	80	1600	25000	22.8	\$1.81	4.64"
50760	15.5	Med.	4,7	15.5OMNIA19/LED/SW/40	Box	100	Cool White	Soft White	4000	80	1600	15000	13.6	\$1.87	4.64"
50790	15.5	Med.	4,7	15.5OMNIA19/LED/SW/50	Box	100	Daylight	Soft White	5000	80	1600	15000	13.6	\$1.87	4.64"
A19															
52281	14	Med.	1,4,7	14A19/LED/SW/30	Box	100	Warm White	Soft White	3000	80	1500	15000	13.6	\$1.69	4.25"
52300	14	Med.	4,7	14A19/LED/SW/30 2PK	Box (2)	100	Warm White	Soft White	3000	80	1500	15000	13.6	\$1.69	4.25"
52291	14	Med.	1,4,7	14A19/LED/SW/50	Box	100	Daylight	Soft White	5000	80	1500	15000	13.6	\$1.69	4.25"

*Based on 3 hrs./day

**Based on 3 hrs./day 11¢/kWh

See individual product specification sheets for dimmer and ballast compatibility on www.westinghouselighting.com.

Footnotes

1 New Item
2 Dimmable3 Low Voltage (12V)
4 Approved for Damp Location5 Approved for Wet Location
6 Indoor Application Only

7 Approved for Use in Totally Enclosed Fixtures

COLOR GENERAL PURPOSE LAMPS

OMNI A19
REDOMNI A19
GREEN

Item No.	Energy Used (Watts)	Lamp Base	Footnotes	Domestic Code	Package Type	Equiv. Incand. Wattage	Color Designation	Finish	Color Temperature (Kelvin)	CRI	Brightness (Lumens)	Avg. Rated Hours	Life in Years*	Est. Yearly Energy Cost**	MOL
SPECIALTY - COLOR OMNI A19															
03153	5	Med.	4,7	5OMNIA19/LED/R	Box	40	—	Red	—	—	—	25000	22.8	\$0.60	4.33"
03152	6	Med.	4,7	6OMNIA19/LED/G	Box	40	—	Green	—	—	—	25000	22.8	\$0.72	4.33"

*Based on 3 hrs./day

**Based on 3 hrs./day 11¢/kWh

SPECIALTY 120-277V LAMPS



OMNI A21

OMNI A23

Item No.	Energy Used (Watts)	Lamp Base	Footnotes	Domestic Code	Package Type	Equiv. Incand. Wattage	Color Designation	Finish	Color Temperature (Kelvin)	CRI	Brightness (Lumens)	Avg. Rated Hours	Life in Years*	Est. Yearly Energy Cost**	MOL
OMNI A21															
51170	19	Med.	4,7	19OMNIA21/LED/SW/120-277V/50	Box	125	Daylight	Soft White	5000	80	2000	25000	22.8	\$2.29	5.55"
51590	25	Med.	4,7	25OMNIA21/LED/SW/120-277V/30	Box	150	Warm White	Soft White	3000	80	2550	25000	22.8	\$3.01	5.47"
51700	25	Med.	4,7	25OMNIA21/LED/SW/120-277V/50	Box	150	Daylight	Soft White	5000	80	2550	25000	22.8	\$3.01	5.47"
OMNI A23															
51600	29	Med.	4,7	29OMNIA23/LED/SW/120-277V/30	Box	200	Warm White	Soft White	3000	80	3050	25000	22.8	\$3.49	6.30"
51710	29	Med.	4,7	29OMNIA23/LED/SW/120-277V/50	Box	200	Daylight	Soft White	5000	80	3050	25000	22.8	\$3.49	6.30"

*Based on 3 hrs./day

**Based on 3 hrs./day 11¢/kWh

GLOBE LAMPS

G16.5
SOFT WHITEG25
SOFT WHITE

Item No.	Energy Used (Watts)	Lamp Base	Footnotes	Domestic Code	Package Type	Equiv. Incand. Wattage	Color Designation	Finish	Color Temperature (Kelvin)	CRI	Brightness (Lumens)	Avg. Rated Hours	Life in Years*	Est. Yearly Energy Cost**	MOL
G16.5 GLOBE															
45131	7	Cand.	2,4,7	7G16.5/LED/DIM/SW/CB/27 1CD	Card	60	Warm White	Soft White	2700	80	500	25000	22.8	\$0.84	2.75"
G25 GLOBE															
53011	6	Med.	2,4,7	6G25/LED/DIM/SW/30	Box	75	Warm White	Soft White	3000	80	590	25000	22.8	\$0.72	4.33"

*Based on 3 hrs./day

**Based on 3 hrs./day 11¢/kWh

See individual product specification sheets for dimmer and ballast compatibility on www.westinghouselighting.com.

Footnotes

1 New Item
2 Dimmable

3 Low Voltage (12V)
4 Approved for Damp Location

5 Approved for Wet Location
6 Indoor Application Only

7 Approved for Use in Totally Enclosed Fixtures

REFLECTOR LAMPS



Item No.	Energy Used (Watts)	Lamp Base	Footnotes	Domestic Code	Package Type	Equiv. Incand. Wattage	Color Designation	Finish	Color Temperature (Kelvin)	CRI	Brightness (Lumens)	Avg. Rated Hours	Life in Years*	Est. Yearly Energy Cost**	MOL
MR11 REFLECTOR															
35153	4	GU10	2,4,7	4MR11/LED/DIM/FL/GU10/30 1CD	Card	35	Warm White	White	3000	80	250	25000	22.8	\$0.48	1.89"
MR16 REFLECTOR															
33638	4.5	GU5.3	2,4,7	4.5MR16/LED/DIM/FL/30	Hanging Box	35	Warm White	Clear	3000	80	360	25000	22.8	\$0.54	1.85"
33491	6.5	GU5.3	2,4,7	6.5MR16/LED/DIM/FL/30	Hanging Box	50	Warm White	Clear	3000	80	500	25000	22.8	\$0.78	1.85"
52730	7	GU10	1,2,4,	7MR16/LED/DIM/FL/GU10/30	Box	50	Warm White	White	3000	80	500	25000	22.8	\$0.84	2.19"
R14 REFLECTOR															
45154	4	Inter.	2,4,7	4R14/LED/DIM/FL/IN/27 1CD	Card	25	Warm White	Soft White	2700	80	280	25000	22.8	\$0.48	2.55"
R20 REFLECTOR															
53050	6.5	Med.	2,4,7	6.5R20/LED/DIM/FL/27	Box	50	Warm White	Frost	2700	80	525	25000	22.8	\$0.78	3.93"
53161	6.5	Med.	2,4,7	6.5R20/LED/DIM/FL/30	Box	50	Warm White	Frost	3000	80	525	25000	22.8	\$0.78	3.93"
50110	6.5	Med.	2,4,7	6.5R20/LED/DIM/FL/40	Box	50	Cool White	Frost	4000	80	525	25000	22.8	\$0.78	3.93"
BR30 & R30 REFLECTOR															
33159	8	GU24	2,4	8R30/LED/DIM/FL/GU24/27	Box	65	Warm White	Frost	2700	80	650	25000	22.8	\$0.96	4.96"
52200	9	Med.	2,4,7	9BR30/LED/DIM/FL/27	Box	65	Warm White	Frost	2700	80	750	25000	22.8	\$1.08	5.24"
52210	9	Med.	2,4,7	9BR30/LED/DIM/FL/30	Box	65	Warm White	Frost	3000	80	750	25000	22.8	\$1.08	5.24"
50081	9	Med.	2,4,7	9BR30/LED/DIM/FL/40	Box	65	Cool White	Frost	4000	80	750	25000	22.8	\$1.08	5.24"
45148	9	Med.	2,4,7	9BR30/LED/DIM/FL/50	Box	65	Daylight	Frost	5000	80	750	25000	22.8	\$1.08	5.24"
R40 REFLECTOR															
53064	16.5	Med.	2,4	16.5R40/LED/DIM/FL/30	Box	85	Warm White	Frost	3000	80	1200	25000	22.8	\$1.99	6.46"
50140	16.5	Med.	2,4	16.5R40/LED/DIM/FL/50	Box	85	Daylight	Frost	5000	80	1200	25000	22.8	\$1.99	6.46"

*Based on 3 hrs./day

**Based on 3 hrs./day 11¢/kWh

See individual product specification sheets for dimmer and ballast compatibility on www.westinghouselighting.com.

Footnotes

1 New Item
2 Dimmable3 Low Voltage (12V)
4 Approved for Damp Location5 Approved for Wet Location
6 Indoor Application Only

7 Approved for Use in Totally Enclosed Fixtures



REFLECTOR LAMPS

Item No.	Energy Used (Watts)	Lamp Base	Footnotes	Domestic Code	Package Type	Equiv. Incand. Wattage	Color Designation	Finish	Color Temperature (Kelvin)	CRI	Brightness (Lumens)	Avg. Rated Hours	Life in Years*	Est. Yearly Energy Cost**	MOL
PAR20 REFLECTOR															
53012	7	Med.	2,5,7	7PAR20/LED/DIM/IndOutFL/30	Box	50	Warm White	Clear	3000	80	490	25000	22.8	\$0.84	3.50"
50000	7	Med.	2,4,7	7PAR20/LED/DIM/FL/40	Box	50	Cool White	Clear	4000	80	490	25000	22.8	\$0.84	3.50"
50010	7	Med.	2,4,7	7PAR20/LED/DIM/FL/50	Box	50	Daylight	Clear	5000	80	490	25000	22.8	\$0.84	3.50"
PAR30 REFLECTOR															
51800	10	Med.	2,5,7	10PAR30S/LED/DIM/IndOutFL/30	Box	75	Warm White	Clear	3000	80	840	25000	22.8	\$1.20	3.58"
51450	10	Med.	2,5,7	10PAR30/LED/DIM/IndOutFL/30	Box	75	Warm White	Clear	3000	80	840	25000	22.8	\$1.20	4.57"
50020	10	Med.	2,4,7	10PAR30/LED/DIM/FL/40	Box	75	Cool White	Clear	4000	80	840	25000	22.8	\$1.20	4.57"
PAR38 REFLECTOR															
53110	15	Med.	2,5,7	15PAR38/LED/DIM/IndOutFL/30	Box	90	Warm White	Clear	3000	80	1350	25000	22.8	\$1.81	5.32"
53114	15	Med.	2,5,7	15PAR38/LED/DIM/IndOutFL/30 2PK	Box (2)	90	Warm White	Clear	3000	80	1350	25000	22.8	\$1.81	5.32"
50071	15	Med.	2,5,7	15PAR38/LED/DIM/IndOutFL/50	Box	90	Daylight	Clear	5000	80	1350	25000	22.8	\$1.81	5.32"

□ IP65 Rated

*Based on 3 hrs./day

**Based on 3 hrs./day 11¢/kWh

INDOOR/OUTDOOR
COLOR REFLECTOR LAMPS

PAR38 RED

PAR38 GREEN

PAR38 BLUE

Item No.	Energy Used (Watts)	Lamp Base	Footnotes	Domestic Code	Package Type	Equiv. Incand. Wattage	Color Designation	Finish	Color Temperature (Kelvin)	CRI	Brightness (Lumens)	Avg. Rated Hours	Life in Years*	Est. Yearly Energy Cost**	MOL
SPECIALTY - COLOR PAR38 REFLECTOR															
33147	15	Med.	5,7	15PAR38/LED/FL/R	Box	100	—	Red	—	—	—	25000	22.8	\$1.81	5.32"
33149	15	Med.	5,7	15PAR38/LED/FL/G	Box	100	—	Green	—	—	—	25000	22.8	\$1.81	5.32"
33151	15	Med.	5,7	15PAR38/LED/FL/B	Box	100	—	Blue	—	—	—	25000	22.8	\$1.81	5.32"

*Based on 3 hrs./day

**Based on 3 hrs./day 11¢/kWh

See individual product specification sheets for dimmer and ballast compatibility on www.westinghouselighting.com.

Footnotes

1 New Item
2 Dimmable3 Low Voltage (12V)
4 Approved for Damp Location5 Approved for Wet Location
6 Indoor Application Only

7 Approved for Use in Totally Enclosed Fixtures



BR30

GROW LAMP

Item No.	Energy Used (Watts)	Lamp Base	Footnotes	Domestic Code	Package Type	Equiv. Incand. Wattage	Color Designation	Color Temperature (Kelvin)	CRI	Brightness (Lumens)	Avg. Rated Hours	Life in Years*	Est. Yearly Energy Cost**	MOL
BR REFLECTOR														
51820	9	Med.	4	9BR30/LED/FL/GROW/G	Box	65	—	—	—	—	25000	22.8	\$1.08	5.12"

*Based on 3 hrs./day

**Based on 3 hrs./day 11¢/kWh

GENERAL PURPOSE
SPECIALTY LAMPS

Item No.	Energy Used (Watts)	Lamp Base	Footnotes	Domestic Code	Package Type	Equiv. Incand. Wattage	Color Designation	Finish	Color Temperature (Kelvin)	CRI	Brightness (Lumens)	Avg. Rated Hours	Life in Years*	Est. Yearly Energy Cost**	MOL
C7															
55110	0.5	Cand.	4,7	0.5C7/LED/CL/CB/27 2CD	Card (2)	4	Warm White	Clear	2700	80	20	15000	13.6	\$0.06	2.00"
55108	0.5	Cand.	4,7	0.5C7/LED/F/CB/27 2CD	Card (2)	4	Warm White	Frost	2700	80	20	15000	13.6	\$0.06	2.00"
55109	0.75	Cand.	4,7	0.75C7/LED/F/CB/27 2CD	Card (2)	7	Warm White	Frost	2700	80	50	15000	13.6	\$0.09	2.00"
S11															
55113	1	Med.	1,4,7	1S11/LED/CL/27 1CD	Card	10	Warm White	Clear	2700	80	80	15000	13.6	\$0.12	2.05"
55112	1	Med.	1,4,7	1S11/LED/W/27 1CD	Card	10	Warm White	White	2700	80	80	15000	13.6	\$0.12	2.05"
45114	1.5	Inter.	4,7	1.5S11/LED/CL/IN/27 1CD	Card	10	Warm White	Clear	2700	80	80	15000	13.6	\$0.18	2.09"
S14															
52810	1	Med.	1,5,7	1.2S14/LED/CL/27 1CD	Card	15	Warm White	Clear	2700	80	120	15000	13.6	\$0.12	3.30"
52820	1	Med.	1,5,7	1.2S14/LED/F/27 1CD	Card	15	Warm White	Frost	2700	80	120	15000	13.6	\$0.12	3.30"
T7															
45119	1.5	Inter.	4,7	1.5T7/LED/CL/IN/27 1CD	Card	15	Warm White	Clear	2700	80	80	15000	13.6	\$0.18	2.09"
33199	8	Med.	4,7	8T7/LED/F/30 1CD	Card	60	Warm White	Frost	3000	80	800	15000	13.6	\$0.96	4.22"

*Based on 3 hrs./day

**Based on 3 hrs./day 11¢/kWh

See individual product specification sheets for dimmer and ballast compatibility on www.westinghouselighting.com.

Footnotes

1 New Item
2 Dimmable3 Low Voltage (12V)
4 Approved for Damp Location5 Approved for Wet Location
6 Indoor Application Only

7 Approved for Use in Totally Enclosed Fixtures

HALOGEN ALTERNATIVE SPECIALTY LAMPS



Item No.	Energy Used (Watts)	Lamp Base	Footnotes	Domestic Code	Volt	Package Type	Equiv. Halogen Wattage	Color Designation	Finish	Color Temperature (Kelvin)	CRI	Brightness (Lumens)	Avg. Rated Hours	Life in Years*	Est. Yearly Energy Cost**	MOL
JCD																
51641	5	G9	2,4,7	5G9/LED/DIM/CL/30	120	Box	40	Warm White	Clear	3000	80	500	25000	22.8	\$0.60	2.13"

*Based on 3 hrs./day

**Based on 3 hrs./day 11¢/kWh

PIN BASE LAMPS

Replacements for 13W, 18W, 32W, and 42W CFL pin-base lamps.



HORIZONTAL PL



VERTICAL PL

Item No.	Energy Used (Watts)	Lamp Base	Footnotes	Domestic Code	Package Type	Equiv. CFL Wattage	Color Designation	Finish	Color Temperature (Kelvin)	CRI	Brightness (Lumens)*	Avg. Rated Hours	Life in Years*	Est. Yearly Energy Cost**	MOL	
HORIZONTAL INSTALLATION																
51481	9	G24Q GX24Q	2,4,7	9PL/H/LED/DIM/G24Q/35	Direct Install	Box	26	Warm White	White	3500	83	1000	50000	45.6	\$1.08	5.20"
VERTICAL INSTALLATION																
51521	9	G24Q GX24Q	1, 2,4,7	9PLV/LED/DIM/G24Q/40	Direct Install	Box	26	Cool White	White	4000	83	1050	50000	45.6	\$1.08	4.65"

Dimmable when used with a compatible dimming ballast.

*Based on 3 hrs./day

**Based on 3 hrs./day 11¢/kWh

* Lumen output is based on ballast type.

◆ DLC qualified

See individual product specification sheets for dimmer and ballast compatibility on www.westinghouselighting.com.

Footnotes

1 New Item

3 Low Voltage (12V)

5 Approved for Wet Location

7 Approved for Use in Totally Enclosed Fixtures

2 Dimmable

4 Approved for Damp Location

6 Indoor Application Only



RECESSED DOWNLIGHTS

All Recessed LED Downlight Kits are UL or ETL Classified.

Item No.	Energy Used (Watts)	Lamp Base	Footnotes	Domestic Code	Package Type	Equiv. Incand. Wattage	Color Designation	Finish	Color Temperature (Kelvin)	Brightness (Lumens)	Avg. Rated Hours	Life in Years*	Est. Yearly Energy Cost**	MOL	MOD
SMOOTH BAFFLE WITH COLOR TEMPERATURE SELECTION															
24 52430	10	Med.	2,5	10R/4"/LED/DIM/FL/27-50	Box	65	Multi 5	Frost	2700/3000/3500/4000/5000	90 750	50000	45.6	\$1.20 2.99"	5.08"	
24 52440	14	Med.	2,5	14R/5-6"/LED/DIM/FL/27-50	Box	100	Multi 5	Frost	2700/3000/3500/4000/5000	90 1100	50000	45.6	\$1.69 3.22"	7.36"	
STEP BAFFLE WITH COLOR TEMPERATURE SELECTION															
24 51401	6.5	Med.	2,5	6.5R/4"/LED/DIM/FL/27-50	Box	65	Multi 5	White	2700/3000/3500/4000/5000	90 550	50000	45.6	\$0.78 2.48"	5.27"	
24 52350	10	Med.	2,5	10R/4"/LED/DIM/FL/27-50	Box	65	Multi 5	White	2700/3000/3500/4000/5000	90 750	50000	45.6	\$1.20 3.11"	5.09"	
24 51411	11	Med.	2,5	11R/5-6"/LED/DIM/FL/27-50	Box	80	Multi 5	White	2700/3000/3500/4000/5000	90 1000	50000	45.6	\$1.32 2.87"	7.48"	
24 52360	14	Med.	2,5	14R/5-6"/LED/DIM/FL/27-50	Box	100	Multi 5	White	2700/3000/3500/4000/5000	90 1100	50000	45.6	\$1.69 3.23"	7.32"	
STEP BAFFLE															
51047	10	Med.	2,5	10R/4"/LED/DIM/FL/30	Box	65	Warm White	Frost	3000	90 670	50000	45.6	\$1.20 2.88"	5.52"	
24 52390	12	Med.	2,5	12R/5-6"/LED/DIM/FL/30	Box	80	Warm White	Frost	3000	90 850	50000	45.6	\$1.45 2.91"	7.24"	
SMOOTH BAFFLE															
41043	8	Med.	2,4	8R/4"/LED/DIM/FL/27	Box	65	Warm White	Frost	2700	80 650	50000	45.6	\$0.96 3.50"	5.04"	
41041	8	Med.	2,4	8R/4"/LED/DIM/FL/30	Box	65	Warm White	Frost	3000	80 650	50000	45.6	\$0.96 3.50"	5.04"	
41040	14	Med.	2,4	14R/5"/LED/DIM/FL/27	Box	80	Warm White	Frost	2700	80 1000	50000	45.6	\$1.69 3.54"	6.30"	
SQUARE STEP BAFFLE															
24 52460	11	Med.	2,5	11R/4"/LED/DIM/SQ/FL/27-50	Box	65	Mutli 5	Frost	2700/3000/3500/4000/5000	90 750	50000	45.6	\$1.32 3.24"	5.00"	
24 52470	14	Med.	1,2,5	14R/5-6"/LED/DIM/SQ/FL/27-50	Box	100	Mutli 5	Frost	2700/3000/3500/4000/5000	90 1100	50000	45.6	\$1.69 3.54"	6.77"	
SLOPED STEP BAFFLE															
50820	10	Med.	2,4	10R/4"/LED/DIM/SLP/FL/27	Box	65	Warm White	Frost	2700	90 650	35000	31.9	\$1.20 3.35"	5.15"	
50830	10	Med.	2,4	10R/4"/LED/DIM/SLP/FL/30	Box	65	Warm White	Frost	3000	90 650	35000	31.9	\$1.20 3.35"	5.15"	
50840	13	Med.	2,4	13R/6"/LED/DIM/SLP/FL/27	Box	80	Warm White	Frost	2700	90 900	35000	31.9	\$1.57 3.50"	7.28"	
50850	13	Med.	2,4	13R/6"/LED/DIM/SLP/FL/30	Box	80	Warm White	Frost	3000	90 900	35000	31.9	\$1.57 3.50"	7.28"	

❖ IP40 Rated

*Based on 3 hrs./day

**Based on 3 hrs./day 11¢/kWh

24 Can be used to comply with the 2022 Title 24, part 6, high efficacy light source requirements.

See individual product specification sheets for dimmer and ballast compatibility on www.westinghouselighting.com.

Footnotes

- | | | | |
|------------|------------------------------|-----------------------------|---|
| 1 New Item | 3 Low Voltage (12V) | 5 Approved for Wet Location | 7 Approved for Use in Totally Enclosed Fixtures |
| 2 Dimmable | 4 Approved for Damp Location | 6 Indoor Application Only | |



SLIM RECESSED DOWNLIGHTS

Item No.	Energy Used (Watts)	Footnotes	Domestic Code	Package Type	Equip. Incand. Wattage	Color Designation	Finish	Color Temperature (Kelvin)	Brightness (Lumens)	Avg. Rated Hours	Life in Years*	Est. Yearly Energy Cost**	MOL	MOD
----------	---------------------	-----------	---------------	--------------	------------------------	-------------------	--------	----------------------------	---------------------	------------------	----------------	---------------------------	-----	-----

ROUND SLIM WITH COLOR TEMPERATURE SELECTION

52011	10	2,5	10R/4"/LED/DIM/SLIM/FL/27-50	Box	65	Multi 5	White	2700/3000/3500/4000/5000	80	650	50000	45.6	\$1.20	1.02" 5.04"
52050	11	2,5	11R/5"/LED/DIM/SLIM/FL/27-50	Box	75	Multi 5	White	2700/3000/3500/4000/5000	80	800	50000	45.6	\$1.32	1.02" 6.29"
52021	12	2,5	12R/6"/LED/DIM/SLIM/FL/27-50	Box	80	Multi 5	White	2700/3000/3500/4000/5000	80	950	50000	45.6	\$1.45	1.02" 7.17"
52450	18	2,5	18R/8"/LED/DIM/WH/SLIM/FL/120-277V/27-50	Box	100	Multi 5	White	2700/3000/3500/4000/5000	80	1600	50000	45.6	\$2.17	1.02" 9.29"

ROUND SLIM STEP BAFFLE WITH COLOR TEMPERATURE SELECTION

52260	10	2,5	10R/4"/LED/DIM/SLIMBAFFLE/FL/27-50	Box	65	Multi 5	White	2700/3000/3500/4000/5000	90	650	50000	45.6	\$1.20	1.42" 5.04"
52270	12	2,5	12R/6"/LED/DIM/SLIMBAFFLE/FL/27-50	Box	80	Multi 5	White	2700/3000/3500/4000/5000	90	900	50000	45.6	\$1.45	1.42" 7.17"

ROUND DEEP STEP BAFFLE WITH COLOR TEMPERATURE SELECTION

52370	12	2,5	12R/4"/LED/DIM/DEEPBAFFLE/FL/27-50	Box	65	Multi 5	White	2700/3000/3500/4000/5000	90	750	50000	45.6	\$1.45	1.74" 5.09"
52380	15	2,5	15R/6"/LED/DIM/DEEPBAFFLE/FL/27-50	Box	100	Multi 5	White	2700/3000/3500/4000/5000	90	1000	50000	45.6	\$1.81	1.86" 7.32"

ROUND SLIM

52161	8	1,2,5	8R/3"/LED/DIM/WH/SLIM/FL/27-50	Box	45	Multi 5	White	2700/3000/3500/4000/5000	90	480	50000	45.6	\$0.96	1.00" 3.74"
52180	7	2,4	7R/3"/LED/DIM/WH/SLIM/FL/40	Box	40	Cool White	White	4000	80	450	50000	45.6	\$0.84	0.98" 3.35"
52190	7	2,4	7R/3"/LED/DIM/WH/SLIM/FL/50	Box	40	Daylight	White	5000	80	450	50000	45.6	\$0.84	0.98" 3.35"
50951	10	2,5	10R/4"/LED/DIM/WH/SLIM/FL/27	Box	65	Warm White	White	2700	90	650	50000	45.6	\$1.20	1.02" 5.04"
50971	10	2,5	10R/4"/LED/DIM/WH/SLIM/FL/30	Box	65	Warm White	White	3000	90	650	50000	45.6	\$1.20	1.02" 5.04"
51031	12	2,5	12R/6"/LED/DIM/WH/SLIM/FL/27	Box	80	Warm White	White	2700	90	900	50000	45.6	\$1.45	1.02" 7.17"
51071	12	2,5	12R/6"/LED/DIM/WH/SLIM/FL/30	Box	80	Warm White	White	3000	90	900	50000	45.6	\$1.45	1.02" 7.17"
51091	12	2,5	12R/6"/LED/DIM/WH/SLIM/FL/40	Box	80	Cool White	White	4000	90	900	50000	45.6	\$1.45	1.02" 7.17"
52001	18	2,4	18R/8"/LED/DIM/WH/SLIM/FL/120-277V/50	Box	100	Daylight	White	5000	90	1500	50000	45.6	\$2.17	1.02" 9.29"

★ Compatible with item #509506913 ▲ Compatible with item #520506913 ◆ Compatible with item #510306913 *Based on 3 hrs./day **Based on 3 hrs./day 11¢/kWh
 + Compatible with Special Order accessory item #509516931 ✦ IP40 Rated
 ■ Compatible with item #509516913 ● Compatible with item #520516931

24 Can be used to comply with the 2022 Title 24, part 6, high efficacy light source requirements.

SLIM RECESSED DOWNLIGHT ACCESSORIES



Item No.	Footnotes	Description	Height	Width	Depth
509516931	*	10 ft. Extension Cord for Slim Recessed Downlights	—	—	—
509506913		Bracket for 4 in. Slim Recessed Downlights	0.03"	26.00"	6.25"
520506913		Bracket for 5 in. Slim Recessed Downlights	0.03"	26.00"	8.35"
510306913		Bracket for 6 in. Slim Recessed Downlights	0.03"	26.00"	8.38"
509516913	1	4 in. & 6 in. Combination Bracket for Slim Recessed Downlights	0.03"	26.00"	8.30"
520516913	1	3 in. & 5 in. Combination Bracket for Slim Recessed Downlights	0.03"	26.00"	8.30"

* SPECIAL ORDER ITEM - CALL YOUR WESTINGHOUSE LIGHTING REPRESENTATIVE FOR ADDITIONAL INFORMATION

See individual product specification sheets for dimmer and ballast compatibility on www.westinghouselighting.com.

Footnotes

- 1 New Item
- 2 Dimmable
- 3 Low Voltage (12V)
- 4 Approved for Damp Location
- 5 Approved for Wet Location
- 6 Indoor Application Only
- 7 Approved for Use in Totally Enclosed Fixtures



GIMBAL RECESSED DOWNLIGHTS

All Gimbal Recessed LED Downlights are ETL Listed.



Item No.	Energy Used (Watts)	Footnotes	Domestic Code	Package Type	Equiv. Incand. Wattage	Color Designation	Finish	Color Temperature (Kelvin)	Brightness (Lumens)	Avg. Rated Hours	Life in Years*	Est. Yearly Energy Cost**	MOL	MOD		
GIMBAL RECESSED DOWNLIGHTS																
24	52121	7	1,2,5	7R/3"/LED/DIM/WH/GIMBAL/27-50	Box	45	Multi 5	White	2700/3000/3500/4000/5000	90	550	50000	45.6	\$084	1.21"	3.76"
24	52141	12	1,2,5	12R/4"/LED/DIM/WH/GIMBAL/27-50	Box	80	Multi 5	White	2700/3000/3500/4000/5000	90	850	50000	45.6	\$1.45	1.38"	5.04"
24	52560	15	1,2,5	15R/6"/LED/DIM/WH/GIMBAL/27-50	Box	100	Multi 5	White	2700/3000/3500/4000/5000	90	1100	50000	45.6	\$1.81	2.00"	7.21"

♦ Compatible with Bracket for 4 in. Slim Recessed Downlights sold separately (Item# 509506913)

*Based on 3 hrs./day

**Based on 3 hrs./day 11¢/kWh

♦ IP40 Rated

■ Compatible with item #509516913

24 Can be used to comply with the 2022 Title 24, part 6, high efficacy light source requirements.



51190

SHOEBOX LAMP

This Shoebox LED Lamp is 100-277V.

Item No.	Energy Used (Watts)	Lamp Base	Footnotes	Domestic Code	Package Type	Equiv. HID Wattage	Color Designation	Finish	Color Temperature (Kelvin)	CRI	Brightness (Lumens)	Avg. Rated Hours	MOL
SHOEBOX LAMP													
51190	80	Mogul/Extended Mogul	4,7	80SB/LED/EX39/50	Box	250	Daylight	Clear	5000	80	9200	50000	8.70"

♦ DLC qualified

See product specification sheet for minimum compartment dimensions.



HIGH-LUMEN LAMPS

All High-Lumen LED Lamps are 120-277V.



Item No.	Energy Used (Watts)	Lamp Base	Footnotes	Domestic Code	Package Type	Equiv. Incand. Wattage	Equiv. CFL Wattage	Equiv. HID Wattage	Color Designation	Finish	Color Temperature (Kelvin)	CRI	Brightness (Lumens)	Avg. Rated Hours	MOL
HIGH LUMEN															
35165	22	Med.	4,7	22T19/LED/HL/50	Box	150	55	100	Daylight	Clear	5000	80	2860	50000	7.09"
35162	36	Med.	4,7	36T30/LED/HL/50	Box	200	65	150	Daylight	Clear	5000	80	4680	50000	8.27"
35163	45	Med.	4,7	45T30/LED/HL/50	Box	300	85	175	Daylight	Clear	5000	80	5850	50000	9.25"
35164	45	Mogul	4,7	45T30/LED/HL/E39/50	Box	300	85	175	Daylight	Clear	5000	80	5850	50000	9.25"
35166	54	Mogul	4,7	54T30/LED/HL/E39/50	Box	400	105	250	Daylight	Clear	5000	80	7020	50000	10.24"
45167	100	Mogul	4,7	100T38/LED/HL/E39/50	Box	750	150	400	Daylight	Clear	5000	80	15000	50000	11.10"
35180	120	Mogul	4,7	120T38/LED/HL/E39/50	Box	1000	250	800	Daylight	Clear	5000	80	18000	50000	13.46"

♦ DLC qualified

See product specification sheet for minimum compartment dimensions.

See individual product specification sheets for dimmer and ballast compatibility on www.westinghouselighting.com.

Footnotes

1 New Item

3 Low Voltage (12V)

5 Approved for Wet Location

7 Approved for Use in Totally Enclosed Fixtures

2 Dimmable

4 Approved for Damp Location

6 Indoor Application Only



FILAMENT HIGH-LUMEN

These LED Lamps are 120-277V.



Item No.	Energy Used (Watts)	Lamp Base	Footnotes	Domestic Code	Package Type	Equiv. Incand. Wattage	Equiv. CFL Wattage	Equiv. HID Wattage	Color Designation	Finish	Color Temperature (Kelvin)	CRI	Brightness (Lumens)	Avg. Rated Hours	MOL
ED23.5 FILAMENT															
52480	14	Med.	5,7	14ED23.5/FilamentLED/CL/120-277V/E26/2150	Box	125	55	50	-	Clear	2150	80	1750	25000	7.09"
52500	14	Med.	5,7	14ED23.5/FilamentLED/CL/120-277V/E26/50	Box	125	55	50	Daylight	Clear	5000	80	2000	25000	7.09"
52510	19	Med.	5,7	19ED23.5/FilamentLED/CL/120-277V/E26/50	Box	150	60	100	Daylight	Clear	5000	80	3000	25000	7.09"
52520	28	Med.	5,7	28ED23.5/FilamentLED/CL/120-277V/E26/50	Box	200	65	150	Daylight	Clear	5000	80	4000	25000	7.60"
ED28 FILAMENT															
52490	32	Med.	5,7	32ED28/FilamentLED/CL/120-277V/E26/2150	Box	300	85	175	-	Clear	2150	80	4500	25000	9.53"
52530	32	Med.	5,7	32ED28/FilamentLED/CL/120-277V/E26/50	Box	300	85	175	Daylight	Clear	5000	80	5000	25000	9.53"
52251	32	EX39	5,7	32ED28/FilamentLED/CL/120-277V/EX39/50	Box	300	85	175	Daylight	Clear	5000	80	5000	25000	8.46"
52540	36	Med.	5,7	36ED28/FilamentLED/CL/120-277V/E26/50	Box	400	105	200	Daylight	Clear	5000	80	6000	25000	9.53"
52341	36	Mogul	5,7	36ED28/FilamentLED/CL/120-277V/E39/50	Box	400	105	200	Daylight	Clear	5000	80	6000	25000	8.46"
52421	45	Mogul	5,7	45ED28/FilamentLED/CL/120-277V/E39/50	Box	500	125	250	Daylight	Clear	5000	80	7500	25000	9.06"
ED32 FILAMENT															
52690+	54	EX39	1,5,7	54ED32/FilamentLED/CL/120-277V/EX39/50	Box	650	135	320	Daylight	Clear	5000	80	10000	50000	9.45"
ED37 FILAMENT															
52670	65	Ext. Mogul	5,7	65ED37/FilamentLED/CL/120-277V/EX39/50	Box	750	150	400	Daylight	Clear	5000	80	12000	25000	11.50"

† DLC qualified

See individual product specification sheets for dimmer and ballast compatibility on www.westinghouselighting.com.

Footnotes

1 New Item
2 Dimmable

3 Low Voltage (12V)
4 Approved for Damp Location

5 Approved for Wet Location
6 Indoor Application Only

7 Approved for Use in Totally Enclosed Fixtures



LINEAR LAMPS

All Linear LED Lamps are
UL Classified and NSF Certified.



Item No.	Energy Used (Watts)	Lamp Base	Footnotes	Domestic Code	Package Type	Lamp Type Replacement	Color Designation	Finish	Color Temperature (Kelvin)	CRI	Brightness (Lumens)	Avg. Rated Hours	MOL
T5 46 INCH													
50801 ■	24	Mini BiPin	4,7	LED 24T5/46"/40 Ballast Bypass	Sleeve	T5	Cool White	White	4000	80	3500	50000	46"
51531 ■	24	Mini BiPin	4,7	LED 24T5/46"/50 DE Ballast Bypass	Sleeve	T5	Daylight	White	5000	80	3500	50000	46"
T8 24 INCH (DesignLights Consortium® qualified product)													
50260 ◆☉	9	Med. BiPin	4,7	LED 9T8/24"/DIM/40 Ballast Bypass	Sleeve	T8 & T12	Cool White	Frost	4000	82	1150	50000	24"
T8 36 INCH (DesignLights Consortium® qualified product)													
50280 ◆☉	12	Med. BiPin	4,7	LED 12T8/36"/DIM/40 Ballast Bypass	Sleeve	T8 & T12	Cool White	Frost	4000	82	1450	50000	36"
T8 48 INCH (DesignLights Consortium® qualified product)													
53739 ◆▶	11	Med. BiPin	4,7	LED 11T8/48"/DIM/40 Direct Install	Sleeve	T8	Cool White	Frost	4000	82	1800	50000	48"
53852 ◆▶	11	Med. BiPin	4,7	LED 11T8/48"/DIM/50 Direct Install	Sleeve	T8	Daylight	Frost	5000	82	1800	50000	48"
52320 ◆▶	14	Med. BiPin	4,7	LED 14T8/48"/DIM/40 Direct Install	Sleeve	T8	Cool White	Frost	4000	82	2200	50000	48"
52330 ◆▶	14	Med. BiPin	4,7	LED 14T8/48"/DIM/50 Direct Install	Sleeve	T8	Daylight	Frost	5000	82	2200	50000	48"
T8 48 INCH SINGLE-ENDED/DOUBLE-ENDED POWERED (DesignLights Consortium® qualified product)													
51561 ◆☉	14	Med. BiPin	4,7	LED 14T8/48"/DIM/40 SE/DE Ballast Bypass	Sleeve	T8 & T12	Cool White	Frost	4000	83	1800	50000	48"
51571 ◆☉	14	Med. BiPin	4,7	LED 14T8/48"/DIM/50 SE/DE Ballast Bypass	Sleeve	T8 & T12	Daylight	Frost	5000	83	1800	50000	48"
51421 ◆☉	17	Med. BiPin	4,7	LED 17T8/48"/DIM/35 SE/DE Ballast Bypass	Sleeve	T8 & T12	Cool White	Frost	3500	83	2100	50000	48"
51431 ◆☉	17	Med. BiPin	4,7	LED 17T8/48"/DIM/40 SE/DE Ballast Bypass	Sleeve	T8 & T12	Cool White	Frost	4000	83	2200	50000	48"
51441 ◆☉	17	Med. BiPin	4,7	LED 17T8/48"/DIM/50 SE/DE Ballast Bypass	Sleeve	T8 & T12	Daylight	Frost	5000	83	2200	50000	48"
T8 96 INCH (DesignLights Consortium® qualified product)													
34051 ◆☉	40	Single Pin	4,7	LED 40T8/96"/DIM/40 Ballast Bypass	Bulk	T8 & T12	Cool White	Frost	4000	82	5500	50000	96"
34052 ◆☉	40	Single Pin	4,7	LED 40T8/96"/DIM/50 Ballast Bypass	Bulk	T8 & T12	Daylight	Frost	5000	82	5500	50000	96"

◆ DLC qualified

■ Replace F54T5HO linear fluorescent lamps.

▶ Dimmable when used with a compatible dimming ballast.

☉ Dimmable when used in conjunction with a (0-10V) dimming system and dimming module sold separately (Item# 502606930).
Ballast Bypass lamps are designed to operate on voltages ranging from 120-277V.

T8 LED BALLAST BYPASS LAMP DIMMER MODULE



502606930

Item No.	Footnotes	Description	Height	Width	Depth
502606930		T8 LED Ballast Bypass Lamp Dimmer Module	1.20"	12.68"	1.70"

See individual product specification sheets for dimmer and ballast compatibility on www.westinghouselighting.com.

Footnotes

- | | | | |
|------------|------------------------------|-----------------------------|---|
| 1 New Item | 3 Low Voltage (12V) | 5 Approved for Wet Location | 7 Approved for Use in Totally Enclosed Fixtures |
| 2 Dimmable | 4 Approved for Damp Location | 6 Indoor Application Only | |

SPECIALTY HALOGEN LIGHTING

Providing bright, white light and long life, our halogen lamps come in a variety of sizes and shapes. These lamps are completely dimmable and can be used anywhere, making them an excellent choice for a variety of lighting solutions.



MR11 GU4 BASE

MR11 LAMPS, DICHROIC (LOW VOLTAGE)

Item No.	Energy Used (Watts)	Lamp Base	Footnotes	Domestic Code	Package Type	Candle Power	Beam Spread	Beam Type	Filament Type	Color Temperature (Kelvin)	Avg. Rated Hours	ANSI Code	Life in Years*	Est. Yearly Energy Cost**	MOL
MR 11 6 VOLT															
04771	5	GU4	1	5MR11Q/NFL/LN	Card	200	16°	Narrow Flood	C8	2900	2000	-	1.8	\$0.60	1.38"
MR11 12 VOLT															
04766	5	GU4	1	5MR11Q/NFL/LN	Card	200	16°	Narrow Flood	C8	2900	2000	-	1.8	\$0.60	1.38"
04761	10	GU4	1	10MR11Q/NFL/LN	Card	650	16°	Narrow Flood	C6	2900	2000	-	1.8	\$1.20	1.38"
04750	20	GU4	1	20MR11Q/NFL/LN	Card	1600	16°	Narrow Flood	CC6	2950	2000	FTC	1.8	\$2.41	1.38"
06214	20	GU4	1,3	20MR11X/FL/LN 2CD	Card (2)	700	30°	Flood	C8	2900	10000	FTD	9.1	\$2.41	1.38"
04748	20	GU4	1	20MR11Q/SP/LN	Card	700	12°	Spot	C8	2800	2000	FTB	1.8	\$2.41	1.38"
04765	35	GU4	1	35MR11Q/NFL/LN	Card	2800	16°	Narrow Flood	C6	3000	2000	FTF	1.8	\$4.22	1.38"

*Based on 3 hrs./day

**Based on 3 hrs./day 11¢/kWh



MR16 CLEAR LENS GU5.3 BASE

MR16 LAMPS, 12 VOLT DICHROIC (LOW VOLTAGE)

Item No.	Energy Used (Watts)	Lamp Base	Footnotes	Domestic Code	Package Type	Candle Power	Beam Spread	Beam Type	Filament Type	Color Temperature (Kelvin)	Avg. Rated Hours	ANSI Code	Life in Years*	Est. Yearly Energy Cost**	MOL
MR16 12 VOLT															
04781	20	GU5.3	1	20MR16Q/FL/LN	Card	600	32°	Flood	C8	2950	2000	BAB	1.8	\$2.41	1.81"
06212	20	GU5.3	1,3	20MR16X/FL/LN 2CD	Card (2)	700	32°	Flood	C8	2950	10000	BAB	9.1	\$2.41	1.81"
04749	20	GU5.3	1	20MR16Q/SP/LN	Card	3500	12°	Spot	C8	2950	2000	ESX	1.8	\$2.41	1.81"

*Based on 3 hrs./day

**Based on 3 hrs./day 11¢/kWh



MR16 GU10 BASE

MR16 LAMPS, 120 VOLT DICHROIC (LINE VOLTAGE)

Item No.	Energy Used (Watts)	Lamp Base	Footnotes	Domestic Code	Package Type	Candle Power	Beam Spread	Beam Type	Filament Type	Color Temperature (Kelvin)	Brightness (Lumens)	Avg. Rated Hours	Life in Years*	Est. Yearly Energy Cost**	MOL
MR16 120 VOLT															
04787	25	GU10	1	25MR16Q/GU10/FL/LN	Card	300	30°	Flood	CC2V	3050	140	2000	1.8	\$3.01	2.00"
04741	35	GU10	1	35MR16Q/GU10/FL/LN	Card	500	32°	Flood	CC2V	2800	180	1500	1.3	\$4.22	2.00"

*Based on 3 hrs./day

**Based on 3 hrs./day 11¢/kWh

Footnotes

- 1 Clear Lens
- 2 Rough Service
- 3 Krypton(K)/Xenon(X)

JC LAMPS (LOW VOLTAGE)

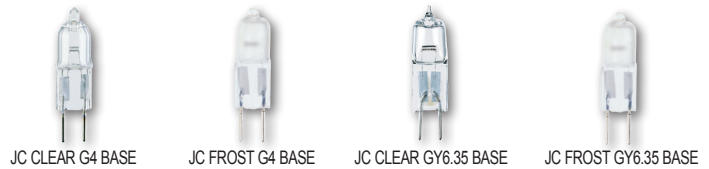

Item No.	Energy Used (Watts)	Lamp Base	Footnotes	Domestic Code	Volts	Package Type	Finish	Filament Type	Color Temperature (Kelvin)	Brightness (Lumens)	Avg. Rated Hours	Life in Years*	Est. Yearly Energy Cost**	MOL
T3														
06240	5	G4		5T3	12	Card	Clear	C8	2800	60	2000	1.8	\$0.60	1.31"
04442	10	G4		10T3	12	Box	Clear	C6	2900	130	2000	1.8	\$1.20	1.19"
04742	10	G4		10T3	12	Card	Clear	C8	2900	120	2000	1.8	\$1.20	1.19"
06216	10	G4	3	10T3X 2CD	12	Card (2)	Clear	C6	2900	100	5000	4.5	\$1.20	1.19"
04444	20	GY6.35		20T3Q	12	Box	Clear	C6	2950	300	2000	1.8	\$2.41	1.63"
04436	20	G4		20T3	12	Box	Clear	C6	2950	300	2000	1.8	\$2.41	1.19"
04736	20	G4		20T3	12	Card	Clear	C8	2950	300	2000	1.8	\$2.41	1.19"
04734	20	G4		20T3/F	12	Card	Frost	C8	2950	290	2000	1.8	\$2.41	1.19"
06209	20	G4	3	20T3X 2CD	12	Card (2)	Clear	C6	2900	300	10000	9.1	\$2.41	1.19"
04438	50	GY6.35		50T3Q	12	Box	Clear	C6	3050	900	2000	1.8	\$6.02	1.63"
T4														
04743	20	GY6.35		20T4Q	12	Card	Clear	C6	2950	300	2000	1.8	\$2.41	1.63"
04745	35	GY6.35		35T4Q	12	Card	Clear	C6	3000	600	2000	1.8	\$4.22	1.63"
04738	50	GY6.35		50T4Q	12	Card	Clear	C6	3050	900	2000	1.8	\$6.02	1.63"
04735	50	GY6.35		50T4Q/F	12	Card	Frost	C6	3050	870	2000	1.8	\$6.02	1.63"
04739	75	GY6.35		75T4Q	12	Card	Clear	C6	3050	1350	2000	1.8	\$9.03	1.63"

*Based on 3 hrs./day **Based on 3 hrs./day 11¢/kWh

JCD LAMPS

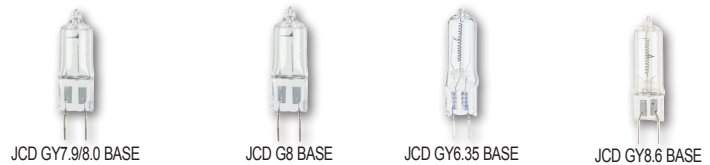

Item No.	Energy Used (Watts)	Lamp Base	Footnotes	Domestic Code	Volts	Package Type	Finish	Filament Type	Color Temperature (Kelvin)	Brightness (Lumens)	Avg. Rated Hours	Life in Years*	Est. Yearly Energy Cost**	MOL
JCD														
04710	20	GY7.9/8.0		20T4Q/GY8/120	120	Card	Clear	CC2V	2700	200	1500	1.3	\$2.41	1.69"
06210	20	G8	3	20T4X/G8/120 2CD	120	Card (2)	Clear	CC2V-H	2700	175	5000	4.5	\$2.41	1.38"
04715	25	GY6.35		25T4Q/120	120	Card	Clear	CC8	2850	255	1500	1.3	\$3.01	1.81"
04721	25	GY7.9/8.0		25T4Q/GY8/120	120	Card	Clear	CC2V	2850	255	1500	1.3	\$3.01	1.69"
04031	35	GY6.35		35T4Q/120	120	Card	Clear	CC2V	2900	380	1500	1.3	\$4.22	1.81"
04722	35	GY7.9/8.0		35T4Q/GY8/120	120	Card	Clear	CC8	2900	380	1500	1.3	\$4.22	1.69"
04712	35	GY8.6		35T4Q/GY8.6/120	120	Card	Clear	CC8	2900	380	1500	1.3	\$4.22	1.81"
04717	50	GY6.35		50T4Q/120	120	Card	Clear	CC2V	2900	600	1500	1.3	\$6.02	1.81"
04889	50	G8		50T4Q/G8/120	120	Card	Clear	CC8	2900	600	1500	1.3	\$6.02	2.25"
04714	75	GY8.6		75T4Q/GY8.6/120	120	Card	Clear	CC8	2900	1050	1500	1.3	\$9.03	2.25"
04764	75	GY7.9/8.0		75T4Q/GY8/130	130	Card	Clear	CC8	2800	975	2000	1.8	\$9.03	2.25"
04719	100	GY6.35		100T4Q/120	120	Card	Clear	CC8	2900	1500	1500	1.3	\$12.05	2.25"
04713	100	GY8.6		100T4Q/GY8.6/120	120	Card	Clear	CC8	2900	1500	1500	1.3	\$12.05	2.25"
04770	100	GY7.9/8.0		100T4Q/GY8/130	130	Card	Clear	CC8	2850	1400	2000	1.8	\$12.05	2.25"

*Based on 3 hrs./day **Based on 3 hrs./day 11¢/kWh

Footnotes
 1 Clear Lens 3 Krypton(K) / Xenon(X)
 2 Rough Service
www.westinghouselighting.com

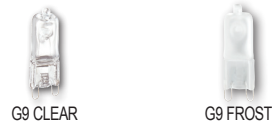

G9 LAMPS, 120 VOLT (LINE VOLTAGE)

Item No.	Energy Used (Watts)	Lamp Base	Footnotes	Domestic Code	Package Type	Finish	Filament Type	Color Temperature (Kelvin)	Brightness (Lumens)	Avg. Rated Hours	Life in Years*	Est. Yearly Energy Cost**	MOL
G9 120 VOLT													
04870	25	G9		25T4Q/G9/120	Card	Clear	CC2V	2800	255	2000	1.8	\$3.01	1.69"
04901	40	G9		40T4Q/G9/120	Box	Clear	CC2V	2800	480	2000	1.8	\$4.82	1.69"
04871	40	G9		40T4Q/G9/120	Card	Clear	CC2V	2800	480	2000	1.8	\$4.82	1.69"
04855	40	G9		40T4Q/G9/F/120	Card	Frost	CC2V	2800	460	2000	1.8	\$4.82	1.69"
04879	60	G9		60T4Q/G9/120	Card	Clear	CC2V	2800	800	2000	1.8	\$7.23	1.69"

*Based on 3 hrs./day **Based on 3 hrs./day 11¢/kWh



SINGLE-ENDED LAMPS, D.C. BAYONET AND E11 BASE

Item No.	Energy Used (Watts)	Lamp Base	Footnotes	Domestic Code	Volts	Package Type	Finish	Filament Type	Color Temperature (Kelvin)	Brightness (Lumens)	Avg. Rated Hours	Life in Years*	Est. Yearly Energy Cost***	MOL
D.C. BAYONET BASE														
04835	50	D.C. Bay.		50Q/DC	120	Card	Clear	CC2V	2900	600	1500	1.3	\$6.02	1.88"
04746	100	D.C. Bay.		100Q/DC	120	Card	Clear	CC8	2950	1500	1500	1.3	\$12.05	2.38"
E11 BASE														
04423	50	E11		50T4Q/E11	120	Box	Clear	CC2V	2900	600	1300	1.1	\$6.02	2.25"
04723	50	E11		50T4Q/E11	120	Card	Clear	CC2V	2900	600	1300	1.1	\$6.02	2.25"
04716	75	E11		75T4Q/E11	120	Card	Clear	CC8	2900	1450	1300	1.1	\$9.03	2.50"
04706	75	E11		75T4Q/F/E11	120	Card	Frost	CC8	2900	1050	1300	1.1	\$9.03	2.50"
04767	100	E11		100T4Q/E11	120	Card	Clear	CC8	2950	1900	1300	1.1	\$12.05	2.69"
04768	150	E11		150T4Q/E11	120	Card	Clear	CC8	3000	2500	1300	1.1	\$18.07	2.69"
04470	500	E11		500T4Q/E11	120	Box	Clear	CC8	3100	9000	2000	1.8	\$60.23	3.50"

*Based on 3 hrs./day **Based on 3 hrs./day 11¢/kWh



T3 SINGLE-ENDED LAMPS, XENON/KRYPTON

Item No.	Energy Used (Watts)	Lamp Base	Footnotes	Domestic Code	Volts	Package Type	Finish	Filament Type	Color Temperature (Kelvin)	Brightness (Lumens)	Avg. Rated Hours	Life in Years*	Est. Yearly Energy Cost**	MOL
T3														
06243	40	E11	3	40T3/KX/E11	120	Card	Clear	CC8	2800	560	2000	1.8	\$4.82	2.50"
06251	40	Cand.	3	40T3/KX/E12	120	Box	Clear	CC8	2800	560	2000	1.8	\$4.82	2.50"
06244	40	Cand.	3	40T3/KX/E12	120	Card	Clear	CC8	2800	560	2000	1.8	\$4.82	2.50"
06254	40	Cand.	3	40T3/KX/F/E12	120	Box	Frost	CC8	2950	540	2000	1.8	\$4.82	2.50"
06252	60	Cand.	3	60T3/KX/E12	120	Box	Clear	CC8	2800	960	2000	1.8	\$7.23	2.50"
06245	60	Cand.	3	60T3/KX/E12	120	Card	Clear	CC8	2800	960	2000	1.8	\$7.23	2.50"
06255	60	Cand.	3	60T3/KX/F/E12	120	Box	Frost	CC8	2950	950	2000	1.8	\$7.23	2.50"

*Based on 3 hrs./day **Based on 3 hrs./day 11¢/kWh

Footnotes

- 1 Clear Lens 3 Krypton(K) / Xenon(X)
- 2 Rough Service

DOUBLE-ENDED LAMPS

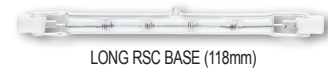

Item No.	Energy Used (Watts)	Lamp Base	Footnotes	Domestic Code	Volts	Package Type	Finish	Filament Type	Color Temperature (Kelvin)	Brightness (Lumens)	Avg. Rated Hours	Life in Years*	Est. Yearly Energy Cost**	MOL
DOUBLE-ENDED, SHORT														
04779	75	RSC		75T3Q	120	Card	Clear	CC2V	2800	1050	1500	1.3	\$9.03	3.07"
04777	100	RSC		100T3Q	120	Card	Clear	CC8	2900	1650	1500	1.3	\$12.05	3.07"
04774	150	RSC		150T3Q	120	Card	Clear	CC8	3000	2600	2000	1.8	\$18.07	3.07"
04974	150	RSC		150T3Q 2CD	120	Card (2)	Clear	CC8	3000	2600	2000	1.8	\$18.07	3.07"
04783	150	RSC	2	150T3Q/RS/130	130	Card	Clear	CC8	3000	2600	1500	1.3	\$18.07	3.07"
04759	250	RSC		250T3Q	120	Card	Clear	CC8	3050	4000	1500	1.3	\$30.11	3.07"
04775	300	RSC		300T3Q	120	Card	Clear	CC2V	3050	5000	1500	1.3	\$36.14	3.07"
DOUBLE-ENDED, LONG														
06242	100	RSC		100T3Q	120	Card	Clear	CC2V	2800	1450	1500	1.3	\$12.05	4.65"
04973	150	RSC		150T3Q 2CD	120	Card (2)	Clear	CC2V	2950	2600	2000	1.8	\$18.07	4.65"
04784	150	RSC	2	150T3Q/RS/130	130	Card	Clear	C8	2950	2400	1500	1.3	\$18.07	4.65"
04976	300	RSC		300T3Q 2CD	120	Card (2)	Clear	C8	3000	5000	2000	1.8	\$36.14	4.65"
04786	300	RSC	2	300T3Q/RS/130	130	Card	Clear	C8	3000	5000	1500	1.3	\$36.14	4.65"
04978	500	RSC		500T3Q 2CD	120	Card (2)	Clear	C8	3050	9500	2000	1.8	\$60.23	4.65"
04788	500	RSC	2	500T3Q/RS/130	130	Card	Clear	C8	3050	9500	1500	1.3	\$60.23	4.65"

*Based on 3 hrs./day

**Based on 3 hrs./day 11¢/kWh

XENON LAMPS (WEDGE)



T5 WEDGE BASE

Item No.	Energy Used (Watts)	Lamp Base	Footnotes	Domestic Code	Volts	Package Type	Finish	Filament Type	Color Temperature (Kelvin)	Brightness (Lumens)	Avg. Rated Hours	Life in Years*	Est. Yearly Energy Cost**	MOL
T5														
06215	18	Wedge	3	18T5X/12V	12	Card	Clear	C2R	2900	210	1000	0.9	\$2.17	1.43"

*Based on 3 hrs./day

**Based on 3 hrs./day 11¢/kWh

Footnotes

1 Clear Lens 3 Krypton(K) / Xenon(X)

2 Rough Service

www.westinghouselighting.com



ALL-PURPOSE, DECORATIVE AND SPECIALTY INCANDESCENT LIGHTING

We offer a wide range of incandescent lamps to meet decorative, general purpose, low voltage, and specialty applications.



FLICKER FLAME LAMP

Item No.	Energy Used (Watts)	Lamp Base	Footnotes	Domestic Code	Volts	Package Type	Finish	Filament Type	Avg. Rated Hours	Color Temperature (Kelvin)	Brightness (Lumens)	Life in Years*	Est. Yearly Energy Cost**	MOL
CA8														
03656	3	Cand.		3CA8/FLK/CB	120	Box	Clear	Flicker	1500	-	-	1.3	\$0.36	3.50"

*Based on 3 hrs./day **Based on 3 hrs./day 11¢/kWh



DECORATIVE SPECIALTY LAMPS

Item No.	Energy Used (Watts)	Lamp Base	Footnotes	Domestic Code	Volts	Package Type	Finish	Filament Type	Avg. Rated Hours	Color Temperature (Kelvin)	Brightness (Lumens)	Life in Years*	Est. Yearly Energy Cost**	MOL
CST6 PUNTINO														
03250	15	Cand.		15CST6/CB	120	Box	Clear	C7A	1500	2700	97	1.3	\$1.81	2.81"
STAR														
03747	7	Cand.		7STAR/CB	120	Box	Clear	C7A	1000	2700	45	0.9	\$0.84	2.75"

*Based on 3 hrs./day **Based on 3 hrs./day 11¢/kWh



FLAMME TWIST LAMPS

Item No.	Energy Used (Watts)	Lamp Base	Footnotes	Domestic Code	Volts	Package Type	Finish	Filament Type	Avg. Rated Hours	Color Temperature (Kelvin)	Brightness (Lumens)	Life in Years*	Est. Yearly Energy Cost**	MOL
CA5 (FLAMME TWIST)														
03241	7.5	Cand.		7.5CA5/CB	120	Box	Clear	C7A	3000	2700	39	2.7	\$0.90	2.81"
03242	7.5	Cand.		7.5CA5/F/CB	120	Box	Frost	C7A	3000	2700	37	2.7	\$0.90	2.81"
03755	7.5	Cand.		7.5CA5/CB 3CD	120	Card (3)	Clear	C7A	3000	2700	39	2.7	\$0.90	2.81"

*Based on 3 hrs./day **Based on 3 hrs./day 11¢/kWh

Footnotes

- 1 Canadian Standards Association 3 Non-Stick Base
- 2 Commercial Service*

FLAME TIP LAMPS

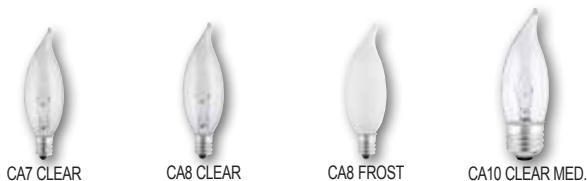

Item No.	Energy Used (Watts)	Lamp Base	Footnotes	Domestic Code	Volts	Package Type	Finish	Filament Type	Avg. Rated Hours	Color Temperature (Kelvin)	Brightness (Lumens)	Life in Years*	Est. Yearly Energy Cost**	MOL
CA7														
03671	10	Cand.		10CA7/CB/130	130	Box	Clear	C7A	2500	2700	58	2.2	\$1.20	2.81"
CA8														
03670	7.5	Cand.	2	7.5CA8/CB/130	130	Box	Clear	C7A	2500	2700	40	2.2	\$0.90	3.50"
03273	15	Cand.		15CA8/CB	120	Box	Clear	CC2V	1500	2700	100	1.3	\$1.81	3.50"
03777	15	Cand.		15CA8/F/CB 2CD	120	Card (2)	Frost	CC2V	1500	2700	90	1.3	\$1.81	3.50"
03673	15	Cand.	2	15CA8/CB/130	130	Box	Clear	C7A	2500	2700	75	2.2	\$1.81	3.50"
03274	25	Cand.		25CA8/CB	120	Box	Clear	CC2V	1500	2700	190	1.3	\$3.01	3.50"
03278	25	Cand.		25CA8/F/CB	120	Box	Frost	CC2V	1500	2700	175	1.3	\$3.01	3.50"
03774	25	Cand.		25CA8/CB 2CD	120	Card (2)	Clear	CC2V	1500	2700	175	1.3	\$3.01	3.50"
03674	25	Cand.	2	25CA8/CB/130	130	Box	Clear	CC2V	2500	2700	158	2.2	\$3.01	3.50"
05106	25	Cand.	2	25CA8/CB/130 25PK	130	Box (25)	Clear	CC2V	2500	2700	158	2.2	\$3.01	3.50"
CA10 Medium Base														
03664	25	Med.	2	25CA10/130	130	Box	Clear	CC2V	2500	2700	190	2.2	\$3.01	4.00"

*Based on 3 hrs./day

**Based on 3 hrs./day 11¢/kWh



TORPEDO LAMPS

Item No.	Energy Used (Watts)	Lamp Base	Footnotes	Domestic Code	Volts	Package Type	Finish	Filament Type	Avg. Rated Hours	Color Temperature (Kelvin)	Brightness (Lumens)	Life in Years*	Est. Yearly Energy Cost**	MOL
B9 1/2														
03681	15	Cand.	2	15B91/2/CB/130	130	Box	Clear	CC2V	2500	2700	100	2.2	\$1.81	3.33"
03282	25	Cand.		25B91/2/CB	120	Box	Clear	CC2V	1500	2700	190	1.3	\$3.01	3.33"
03285	25	Cand.		25B91/2/F/CB	120	Box	Frost	CC2V	1500	2700	175	1.3	\$3.01	3.33"
03682	25	Cand.	2	25B91/2/CB/130	130	Box	Clear	CC2V	2500	2700	170	2.2	\$3.01	3.33"
B11														
03734	25	Med.		25B11/F 2CD	120	Card (2)	Frost	CC2V	1500	2700	175	1.3	\$3.01	3.63"

*Based on 3 hrs./day

**Based on 3 hrs./day 11¢/kWh



VINTAGE INSPIRED LAMPS

Item No.	Energy Used (Watts)	Lamp Base	Footnotes	Domestic Code	Volts	Package Type	Finish	Filament Type	Avg. Rated Hours	Color Temperature (Kelvin)	Brightness (Lumens)	Life in Years*	Est. Yearly Energy Cost**	MOL
ST20														
04132	60	Med.		VINTAGE/60/ST20	120	Card	Clear	19-ANCHOR	1500	2200	305	1.3	\$7.23	5.51"
T12														
04129	60	Med.		VINTAGE/60/T12	120	Card	Clear	12-ANCHOR	1500	2200	120	1.3	\$7.23	4.25"

*Based on 3 hrs./day

**Based on 3 hrs./day 11¢/kWh

Footnotes

1 Canadian Standards Association 

3 Non-Stick Base

2 Commercial Service*

www.westinghouselighting.com

A15
APPLIANCE
LAMPS



Item No.	Energy Used (Watts)	Lamp Base	Footnotes	Domestic Code	Volts	Package Type	Finish	Filament Type	Avg. Rated Hours	Color Temperature (Kelvin)	Brightness (Lumens)	Life in Years*	Est. Yearly Energy Cost**	MOL
A15														
03995	15	Med.	1	15A15 2PK	120	Box (2)	Clear	C9	2500	2700	100	2.2	\$1.81	3.38"
03996	15	Med.	1	15A15/F 2PK	120	Box (2)	Frost	C9	2500	2700	90	2.2	\$1.81	3.38"
04503	15	Med.	1,2	15A15/F/130 2PK	130	Box (2)	Frost	C9	2500	2700	90	2.2	\$1.81	3.38"
03925	25	Med.		25A15 2PK	120	Box (2)	Clear	C9	2500	2700	175	2.2	\$3.01	3.38"
03929	25	Med.	1	25A15/F 2PK	120	Box (2)	Frost	C9	2500	2700	160	2.2	\$3.01	3.38"
03926	40	Med.	1	40A15 2PK	120	Box (2)	Clear	C9	2500	2700	350	2.2	\$4.82	3.38"
03930	40	Med.	1	40A15/F 2PK	120	Box (2)	Frost	C9	2500	2700	340	2.2	\$4.82	3.38"
04001	40	Med.	1	40A15	120	Card	Clear	C9	2500	2700	350	2.2	\$4.82	3.38"
04002	40	Med.	1	40A15/F	120	Card	Frost	C9	2500	2700	340	2.2	\$4.82	3.38"
04502	40	Med.	2	40A15/130 2PK	130	Box (2)	Clear	C9	2500	2700	350	2.2	\$4.82	3.38"
04504	40	Med.	1,2	40A15/F/130 2PK	130	Box (2)	Frost	C9	2500	2700	340	2.2	\$4.82	3.38"

*Based on 3 hrs./day

**Based on 3 hrs./day 11¢/kWh

A19
LAMPS



Item No.	Energy Used (Watts)	Lamp Base	Footnotes	Domestic Code	Volts	Package Type	Finish	Filament Type	Avg. Rated Hours	Color Temperature (Kelvin)	Brightness (Lumens)	Life in Years*	Est. Yearly Energy Cost**	MOL
A19														
03935	25	Med.		25A/F 2PK	120	Box (2)	Frost	CC6	1000	2700	230	0.9	\$3.01	4.13"
03963	25	Med.		25A 4PK	120	Box (4)	Clear	CC6	1000	2700	230	0.9	\$3.01	4.13"
04100	25	Med.	2	25A/F/130 4PK	130	Box (4)	Frost	CC6	5000	2700	205	4.5	\$3.01	4.13"

*Based on 3 hrs./day

**Based on 3 hrs./day 11¢/kWh

A19
SPECIALTY
LAMPS



Item No.	Energy Used (Watts)	Lamp Base	Footnotes	Domestic Code	Volts	Package Type	Finish	Filament Type	Avg. Rated Hours	Color Temperature (Kelvin)	Brightness (Lumens)	Life in Years*	Est. Yearly Energy Cost**	MOL
A19														
03443	25	Med.		25A/TA	120	Box	Transparent Amber	C9	2500	-	-	2.2	\$3.01	4.13"
03444	25	Med.		25A/TG	120	Box	Transparent Green	C9	2500	-	-	2.2	\$3.01	4.13"
03445	25	Med.		25A/TB	120	Box	Transparent Blue	C9	2500	-	-	2.2	\$3.01	4.13"
03446	25	Med.		25A/TR	120	Box	Transparent Red	C9	2500	-	-	2.2	\$3.01	4.13"
03452	60	Med.		60A/Y 2PK	120	Box (2)	Yellow Bug Light	C9	1000	-	-	0.9	\$7.23	4.13"

*Based on 3 hrs./day

**Based on 3 hrs./day 11¢/kWh

Footnotes

1 Canadian Standards Association  3 Non-Stick Base
2 Commercial Service*



PS30 CLEAR

PS30 LAMP

Item No.	Energy Used (Watts)	Lamp Base	Footnotes	Domestic Code	Volts	Package Type	Finish	Filament Type	Avg. Rated Hours	Color Temperature (Kelvin)	Brightness (Lumens)	Life in Years*	Est. Yearly Energy Cost**	MOL
PS30														
03974	300	Med.		300PS30	120	Box	Clear	C9	750	2850	5870	0.6	\$36.14	8.00"

*Based on 3 hrs./day

**Based on 3 hrs./day 11¢/kWh

G12½ AND G16½ LAMPS



G12 1/2 CLEAR

G16 1/2 CLEAR

G16 1/2 WHITE

Item No.	Energy Used (Watts)	Lamp Base	Footnotes	Domestic Code	Volts	Package Type	Finish	Filament Type	Avg. Rated Hours	Color Temperature (Kelvin)	Brightness (Lumens)	Life in Years*	Est. Yearly Energy Cost**	MOL
G12 1/2														
03831	10	Cand.		10G121/2/CB	120	Box	Clear	C7A	1500	2700	58	1.3	\$1.20	2.25"
G16 1/2														
03822	25	Cand.		25G161/2/CB	120	Box	Clear	CC2V	1500	2700	175	1.3	\$3.01	2.75"
03636	25	Cand.	2	25G161/2/W/CB/130	130	Box	White	CC2V	2500	2700	155	2.2	\$3.01	2.75"

*Based on 3 hrs./day

**Based on 3 hrs./day 11¢/kWh

G25½ CHROME LAMPS



1/2 CHROME

Item No.	Energy Used (Watts)	Lamp Base	Footnotes	Domestic Code	Volts	Package Type	Finish	Filament Type	Avg. Rated Hours	Color Temperature (Kelvin)	Brightness (Lumens)	Life in Years*	Est. Yearly Energy Cost**	MOL
G25														
03156	40	Med.		40G25/CH	120	Box	1/2 Chrome	C9	750	2700	-	0.6	\$4.82	4.38"
03157	60	Med.		60G25/CH	120	Box	1/2 Chrome	C9	750	2700	-	0.6	\$7.23	4.38"

*Based on 3 hrs./day

**Based on 3 hrs./day 11¢/kWh



CLEAR

WHITE

G40 LAMPS

Item No.	Energy Used (Watts)	Lamp Base	Footnotes	Domestic Code	Volts	Package Type	Finish	Filament Type	Avg. Rated Hours	Color Temperature (Kelvin)	Brightness (Lumens)	Life in Years*	Est. Yearly Energy Cost**	MOL
G40														
03102	60	Med.		60G40	120	Box	Clear	CC6	2500	2700	722	2.2	\$7.23	6.75"
03107	60	Med.		60G40/W	120	Box	White	CC6	2500	2700	650	2.2	\$7.23	6.75"
03108	100	Med.		100G40/W	120	Box	White	CC6	2500	2700	1221	2.2	\$12.05	6.75"

*Based on 3 hrs./day

**Based on 3 hrs./day 11¢/kWh

Footnotes

1 Canadian Standards Association  3 Non-Stick Base
 2 Commercial Service*

R20
REFLECTOR LAMP



Item No.	Energy Used (Watts)	Lamp Base	Footnotes	Domestic Code	Volts	Package Type	Finish	Beam Type	Filament Type	Avg. Rated Hours	Color Temperature (Kelvin)	Brightness (Lumens)	Life in Years*	Est. Yearly Energy Cost**	MOL
R20															
04303	30	Med.	1	30R20/FL	120	Box	Frost	Flood	CC6	2000	2700	215	1.8	\$3.61	4.00"

*Based on 3hrs./day **Based on operating 3hrs./day 11¢/kWh

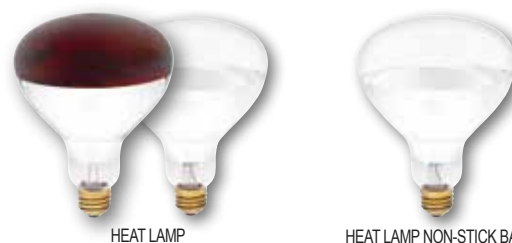

R40
INFRARED HEAT LAMPS (SPLATTER RESISTANT)

Item No.	Energy Used (Watts)	Lamp Base	Footnotes	Domestic Code	Volts	Package Type	Finish	Beam Type	Filament Type	Avg. Rated Hours	Life in Years*	Est. Yearly Energy Cost**	MOL
R40													
03918	125	Med.		125R40/HT	120	Box	Clear	Flood	C9	5000	4.5	\$15.06	6.50"
03916	250	Med.		250R40/HT	120	Box	Clear	Flood	C9	5000	4.5	\$30.11	6.50"
03484	250	Med.	3	250R40/HT/EZ	120	Box	Clear	Flood	C9	5000	4.5	\$30.11	6.50"
03917	250	Med.		250R40/HT/R	120	Box	Red	Flood	C9	5000	4.5	\$30.11	6.50"
03915	375	Med.		375R40/HT	120	Box	Clear	Flood	C9	5000	4.5	\$45.17	6.50"

*Based on 3 hrs./day **Based on 3 hrs./day 11¢/kWh



BR38
INDOOR/OUTDOOR LAMPS

Item No.	Energy Used (Watts)	Lamp Base	Footnotes	Domestic Code	Volts	Package Type	Finish	Beam Type	Filament Type	Avg. Rated Hours	Color Temperature (Kelvin)	Brightness (Lumens)	Life in Years*	Est. Yearly Energy Cost**	MOL
BR38															
04409	100	Med.		100BR38/Y/FL	120	Box	Yellow	Flood	C9	2000	-	-	1.8	\$12.05	5.75"
04410	100	Med.		100BR38/R/FL	120	Box	Red	Flood	C9	2000	-	-	1.8	\$12.05	5.75"
04411	100	Med.		100BR38/A/FL	120	Box	Amber	Flood	C9	2000	-	-	1.8	\$12.05	5.75"
04413	100	Med.		100BR38/G/FL	120	Box	Green	Flood	C9	2000	-	-	1.8	\$12.05	5.75"

*Based on 3 hrs./day **Based on 3 hrs./day 11¢/kWh

Footnotes

- 1 Canadian Standards Association
- 2 Commercial Service* 3 Non-Stick Base



C7 LAMPS

Item No.	Energy Used (Watts)	Lamp Base	Footnotes	Domestic Code	Volts	Package Type	Finish	Filament Type	Avg. Rated Hours	Color Temperature (Kelvin)	Brightness (Lumens)	Life in Years*	Est. Yearly Energy Cost**	MOL
C7														
03601	4	Cand.		4C7/CB	120	Box	Clear	C7A	3000	2700	20	2.7	\$0.48	2.11"
03794	4	Cand.		4C7/CB 2CD	120	Card (2)	Clear	C7A	3000	2700	20	2.7	\$0.48	2.11"
03795	4	Cand.		4C7/W/CB 2CD	120	Card (2)	White	C7A	3000	2700	19	2.7	\$0.48	2.11"
04794	4	Cand.		4C7/CB 4CD	120	Card (4)	Clear	C7A	3000	2700	20	2.7	\$0.48	2.11"
04795	4	Cand.		4C7/W/CB 4CD	120	Card (4)	White	C7A	3000	2700	19	2.7	\$0.48	2.11"
03691	7	Cand.		7C7/CB	120	Box	Clear	C7A	3000	2700	45	2.7	\$0.84	2.11"
03791	7	Cand.		7C7/CB 2CD	120	Card (2)	Clear	C7A	3000	2700	45	2.7	\$0.84	2.11"
03792	7	Cand.		7C7/W/CB 2CD	120	Card (2)	White	C7A	3000	2700	35	2.7	\$0.84	2.11"
37202	7	Cand.		7C7/CB 4CD	120	Card (4)	Clear	C7A	4000	2700	43	3.6	\$0.84	2.11"
37206	7	Cand.		7C7/W/CB 4CD	120	Card (4)	White	C7A	4000	2700	34	3.6	\$0.84	2.11"

*Based on 3 hrs./day **Based on 3 hrs./day 11¢/kWh

S6, S11 AND S14 LAMPS



Item No.	Energy Used (Watts)	Lamp Base	Footnotes	Domestic Code	Volts	Package Type	Finish	Filament Type	Avg. Rated Hours	Color Temperature (Kelvin)	Brightness (Lumens)	Life in Years*	Est. Yearly Energy Cost**	MOL
S6														
04025	6	Cand.		6S6/CB 2CD	120	Card (2)	Clear	C7A	1500	2700	32	1.3	\$0.72	1.88"
04525	6	Cand.	2	6S6/CB/130	130	Box	Clear	C7A	1500	2700	32	1.3	\$0.72	1.88"
S11														
04064	7.5	Med.		7.5S11	120	Card	Clear	C7A	1500	2700	53	1.3	\$0.90	2.25"
04065	7.5	Med.		7.5S11/W	120	Card	White	C7A	1500	2700	39	1.3	\$0.90	2.25"
04067	7.5	Med.		7.5S11/R	120	Card	Red	C7A	2500	-	-	2.2	\$0.90	2.25"
04564	7.5	Med.		7.5S11/130	130	Box	Clear	C7A	2500	2700	52	2.2	\$0.90	2.25"
03568	10	Inter.		10S11/IN/130	130	Card	Clear	C7A	2500	2700	80	2.2	\$1.20	2.25"
03534	25	Inter.		25S11/IN	120	Card	Clear	CC2V	1000	2700	180	0.9	\$3.01	2.25"
03729	40	Inter.		40S11/IN	120	Card	Clear	CC2V	1000	2700	355	0.9	\$4.82	2.25"
S14														
04340	11	Med.		11S14/130	130	Box	Clear	C9	2500	2700	63	2.2	\$1.32	3.38"
03540	11	Med.		11S14/130	130	Card	Clear	C9	2500	2700	63	2.2	\$1.32	3.38"
03541	11	Med.		11S14/F/130	130	Card	Frost	C9	2500	2700	60	2.2	\$1.32	3.38"

*Based on 3 hrs./day **Based on 3 hrs./day 11¢/kWh

LOW VOLTAGE LAMPS



Item No.	Energy Used (Watts)	Lamp Base	Footnotes	Domestic Code	Volts	Package Type	Finish	Filament Type	Avg. Rated Hours	Color Temperature (Kelvin)	Brightness (Lumens)	Life in Years*	Est. Yearly Energy Cost**	MOL
S8														
03726	12	S.C. Bay.		12S8/93T/SC/12V 2CD	12	Card (2)	Clear	C6	700	2700	120	0.6	\$1.45	2.00"
03727	21	S.C. Bay.		21S8/1073/SC/12V 2CD	12	Card (2)	Clear	C6	700	2700	255	0.6	\$2.53	2.00"

*Based on 3 hrs./day **Based on 3 hrs./day 11¢/kWh

Footnotes
 1 Canadian Standards Association 3 Non-Stick Base
 2 Commercial Service*

T4, T6
AND T6½ LAMPS



Item No.	Energy Used (Watts)	Lamp Base	Footnotes	Domestic Code	Volts	Package Type	Finish	Filament Type	Avg. Rated Hours	Color Temperature (Kelvin)	Brightness (Lumens)	Life in Years*	Est. Yearly Energy Cost**	MOL
T4														
03226	15	Cand.		15T4/CB	120	Card	Clear	C5	1000	2700	100	0.9	\$1.81	1.75"
T6														
03723	15	Cand.		15T6/F/CB	120	Card	Frost	C7A	1000	2700	89	0.9	\$1.81	3.00"
03882	15	Cand.		15T6/CB/130	130	Box	Clear	C7A	1500	2700	100	1.3	\$1.81	3.00"
03883	15	Cand.		15T6/CB/145	145	Box	Clear	C7A	1500	2700	100	1.3	\$1.81	3.00"
03583	15	Cand.		15T6/CB/145	145	Card	Clear	C7A	1500	2700	100	1.3	\$1.81	3.00"
03220	25	Cand.		25T6/CB	120	Box	Clear	C7A	1500	2700	190	1.3	\$3.01	3.00"
03520	25	Cand.		25T6/CB	120	Card	Clear	C7A	1500	2700	190	1.3	\$3.01	3.00"
T6 1/2														
04316	20	Inter.		20T61/2/IN/130	130	Box	Clear	C8	3000	2600	100	2.7	\$2.41	5.38"
04319	20	Inter.		20T61/2/F/IN/130	130	Box	Frost	C8	3000	2700	90	2.7	\$2.41	5.38"
03707	40	Inter.		40T61/2/IN	120	Card	Clear	C8	1000	2700	250	0.9	\$4.82	5.38"

*Based on 3 hrs./day **Based on 3 hrs./day 11¢/kWh

T7, T7½
and T8 LAMPS



Item No.	Energy Used (Watts)	Lamp Base	Footnotes	Domestic Code	Volts	Package Type	Finish	Filament Type	Avg. Rated Hours	Color Temperature (Kelvin)	Brightness (Lumens)	Life in Years*	Est. Yearly Energy Cost**	MOL
T7														
03720	15	Cand.		15T7/CB	120	Card	Clear	C5	1000	2700	108	0.9	\$1.81	2.19"
03721	15	Inter.		15T7/IN	120	Card	Clear	C5	1000	2700	108	0.9	\$1.81	2.19"
03722	15	D.C. Bay.		15T7/DC	120	Card	Clear	C5	1000	2700	108	0.9	\$1.81	2.19"
T7 1/2														
03521	35	Cand.		35T71/2/CB	120	Card	Clear	C5	1500	2700	190	1.3	\$4.22	3.56"
T8														
03716	25	Inter.		25T8/IN	120	Card	Clear	C5	1000	2700	195	0.9	\$3.01	2.56"
03717	25	D.C. Bay.		25T8/DC	120	Card	Clear	C5	1000	2700	195	0.9	\$3.01	2.56"
03719	40	Inter.		40T8/IN	120	Card	Clear	C7A	1000	2700	365	0.9	\$4.82	2.56"
03892	40	Med.		40T8/130	130	Box	Clear	C8	3500	2700	300	3.1	\$4.82	11.50"

*Based on 3 hrs./day **Based on 3 hrs./day 11¢/kWh

T10 LAMPS



Item No.	Energy Used (Watts)	Lamp Base	Footnotes	Domestic Code	Volts	Package Type	Finish	Filament Type	Avg. Rated Hours	Color Temperature (Kelvin)	Brightness (Lumens)	Life in Years*	Est. Yearly Energy Cost**	MOL
T10														
03710	25	Med.		25T10	120	Card	Clear	C5V	1000	2700	180	0.9	\$3.01	5.13"
03713	25	Med.		25T10/F	120	Card	Frost	C5V	1000	2700	170	0.9	\$3.01	5.13"

*Based on 3 hrs./day **Based on 3 hrs./day 11¢/kWh

Footnotes

- 1 Canadian Standards Association 3 Non-Stick Base
- 2 Commercial Service*

ITEM#	PAGE#	ITEM#	PAGE#	ITEM#	PAGE#	ITEM#	PAGE#
03102	27	03747	24	04706	22	04976	23
03107	27	03755	24	04710	21	04978	23
03108	27	03774	25	04712	21	05106	25
03152	10	03777	25	04713	21	06209	21
03153	10	03791	29	04714	21	06210	21
03156	27	03792	29	04715	21	06212	20
03157	27	03794	29	04716	22	06214	20
03220	30	03795	29	04717	21	06215	23
03226	30	03822	27	04719	21	06216	21
03241	24	03831	27	04721	21	06240	21
03242	24	03882	30	04722	21	06242	23
03250	24	03883	30	04723	22	06243	22
03273	25	03892	30	04734	21	06244	22
03274	25	03915	28	04735	21	06245	22
03278	25	03916	28	04736	21	06251	22
03282	25	03917	28	04738	21	06252	22
03285	25	03918	28	04739	21	06254	22
03443	26	03925	26	04741	20	06255	22
03444	26	03926	26	04742	21	33147	12
03445	26	03929	26	04743	21	33149	12
03446	26	03930	26	04745	21	33151	12
03452	26	03935	26	04746	22	33159	11
03484	28	03963	26	04748	20	33191	8
03520	30	03974	27	04749	20	33193	5
03521	30	03995	26	04750	20	33199	13
03534	29	03996	26	04759	23	33491	11
03540	29	04001	26	04761	20	33638	11
03541	29	04002	26	04764	21	34051	19
03568	29	04025	29	04765	20	34052	19
03583	30	04031	21	04766	20	35153	11
03601	29	04064	29	04767	22	35162	17
03636	27	04065	29	04768	22	35163	17
03656	24	04067	29	04770	21	35164	17
03664	25	04100	26	04771	20	35165	17
03670	25	04129	25	04774	23	35166	17
03671	25	04132	25	04775	23	35180	17
03673	25	04303	28	04777	23	37202	29
03674	25	04316	30	04779	23	37206	29
03681	25	04319	30	04781	20	41040	15
03682	25	04340	29	04783	23	41041	15
03691	29	04409	28	04784	23	41043	15
03707	30	04410	28	04786	23	43166	7
03710	30	04411	28	04787	20	43169	5
03713	30	04413	28	04788	23	43171	5
03716	30	04423	22	04794	29	43172	7
03717	30	04436	21	04795	29	43697	9
03719	30	04438	21	04835	22	45114	13
03720	30	04442	21	04855	22	45119	13
03721	30	04444	21	04870	22	45124	8
03722	30	04470	22	04871	22	45129	8
03723	30	04502	26	04879	22	45131	10
03726	29	04503	26	04889	21	45134	8
03727	29	04504	26	04901	22	45136	8
03729	29	04525	29	04973	23	45138	9
03734	25	04564	29	04974	23	45140	9

ITEM#	PAGE#	ITEM#	PAGE#	ITEM#	PAGE#	ITEM#	PAGE#
45141	9	51421	19	52480	18	55112	13
45148	11	51431	19	52490	18	55113	13
45154	11	51441	19	52500	18	55145	9
45156	9	51450	12	52510	18	502606930	19
45160	9	51481	14	52520	18	509506913	16
45167	17	51521	14	52530	18	509516913	16
45171	5	51531	19	52540	18	509516931	16
45172	5	51561	19	52550	7	510306913	16
45182	7	51571	19	52560	17	520506913	16
45183	7	51581	6	52570	7	520516913	16
45184	6	51590	10	52580	7		
45185	6	51600	10	52590	7		
45186	7	51641	14	52600	7		
45187	7	51672	7	52610	7		
45188	6	51681	6	52620	7		
50000	12	51691	7	52630	5		
50010	12	51700	10	52640	5		
50020	12	51710	10	52651	5		
50071	12	51800	12	52660	5		
50081	11	51820	13	52670	18		
50110	11	51840	9	52680	7		
50140	11	51941	6	52690	18		
50163	7	51970	9	52710	5		
50172	7	52001	16	52720	5		
50242	7	52011	16	52730	11		
50260	19	52021	16	52750	8		
50280	19	52050	16	52760	8		
50592	5	52121	17	52770	5		
50621	5	52141	17	52780	5		
50691	8	52161	16	52790	5		
50750	9	52180	16	52800	5		
50760	9	52190	16	52810	13		
50771	9	52200	11	52820	13		
50790	9	52210	11	53011	10		
50801	19	52240	7	53012	12		
50811	9	52251	18	53032	11		
50820	15	52260	16	53050	11		
50830	15	52270	16	53064	11		
50840	15	52281	9	53110	12		
50850	15	52291	9	53114	12		
50940	9	52300	9	53127	9		
50951	16	52320	19	53140	9		
50971	16	52330	19	53158	9		
51031	16	52341	18	53161	11		
51047	15	52350	15	53164	7		
51071	16	52360	15	53165	7		
51091	16	52370	16	53175	7		
51170	10	52380	16	53178	7		
51190	17	52390	15	53189	9		
51321	9	52421	18	53190	9		
51331	9	52430	15	53739	19		
51341	9	52440	15	53852	19		
51361	7	52450	16	55108	13		
51401	15	52460	15	55109	13		
51411	15	52470	15	55110	13		



Call 1-800-999-2226 or visit www.westinghouselighting.com.

 and Westinghouse are trademarks of Westinghouse Electric Corporation.
Used under license by Westinghouse Lighting. All Rights Reserved.